

Archaeological evaluation at Land Southwest of Clifton-upon-Dunsmore, Warwickshire

Interim report

Worcestershire Archaeology

for Marrons Planning

on behalf of Richborough Estates

March 2026



Find out more online:
www.explorethepast.co.uk



LAND SOUTHWEST OF CLIFTON-UPON-DUNSMORE WARWICKSHIRE

Archaeological evaluation report



©Worcestershire County Council

Worcestershire Archaeology
Worcestershire Archive & Archaeology Service
The Hive
Sawmill Walk
The Butts
Worcester
WR1 3PD

Explore
the Past

SITE INFORMATION

Site name: Land Southwest of Clifton-upon-Dunsmore, Warwickshire
Site code: CLIFF26
Local planning authority: Warwickshire County Council
Planning reference: Pre-application
Central NGR: SP 52657 75977
Commissioning client: Marrons Planning on behalf of Richborough Estates
WA project number: P7108
WA report number: 3405
HER reference:
Oasis reference: fieldsec1-540452
Museum accession number: RTA 1170

DOCUMENT CONTROL PANEL				
Version	Date	Author	Details	Reviewed and approved by
1	04/03/2026	Graham Arnold	Draft interim submitted to Consultant	Rupert Lotherington

This report is confidential to the client. Worcestershire Archaeology accepts no responsibility or liability to any third party to whom this report, or any part of it, is made known. Any such party relies upon this report entirely at their own risk. No part of this report may be reproduced by any means without permission.

CONTENTS

SUMMARY	1
REPORT	3
1 INTRODUCTION	3
1.1 Background to the project	3
1.2 Site location, topography and geology.....	3
2 ARCHAEOLOGICAL AND HISTORICAL BACKGROUND	3
2.1 Introduction	3
2.2 Prehistoric/Iron Age/Roman.....	3
2.3 Medieval	4
2.4 Post-Medieval/Modern	4
2.5 Previous archaeological work on the site	4
3 PROJECT AIMS	4
4 PROJECT METHODOLOGY	5
5 ARCHAEOLOGICAL RESULTS	5
5.1 Introduction	5
5.2 Trench descriptions.....	5
5.2.1 Natural deposits across the site.....	5
5.2.2 Blank trenches.....	6
5.2.3 Field 1 features	6
5.2.4 Modern deposits.....	10
6 ARTEFACTUAL EVIDENCE – INTERIM ASSESSMENT	10
6.1 Aims.....	10
6.2 Methodology.....	10
6.2.1 Recovery policy	10
6.2.2 Method of analysis	10
6.2.3 Discard policy	10
6.3 Results	10
6.4 Discussion	11
7 ENVIRONMENTAL EVIDENCE	12
8 DISCUSSION AND CONCLUSIONS	12
9 PROJECT PERSONNEL	13
10 ACKNOWLEDGEMENTS	13
11 BIBLIOGRAPHY	13

FIGURES

APPENDIX 1: TRENCH DESCRIPTIONS

APPENDIX 2: SUMMARY OF PROJECT ARCHIVE

APPENDIX 3: HER DATA

Archaeological evaluation at land southwest of Clifton-Upon-Dunsmore, Warwickshire – Interim report

By Graham Arnold

With contributions by Peter Lovett and Laura Griffin

Illustrations by Abbie Horton

Summary

During late winter 2026, an archaeological evaluation was undertaken at land southwest of Clifton-Upon-Dunsmore, Warwickshire (the Site). The project was commissioned by Tom Linington, Principal Heritage Planner at Marrons Planning on behalf of Richborough Estates Ltd, in support of a planning application for a proposed residential development of the Site.

A recent geophysical survey on the Site, undertaken by Curae Terrae in 2025, identified a series of anomalies in the northern portion part of the Site which were consistent with late prehistoric or Romano-British settlement activity as well as ring ditches and a possible prehistoric pit alignment. An aerial photographic survey of the Site also identified a series of cropmarks consistent with a sub-rectangular enclosure of probable late prehistoric or Roman provenance.

Accordingly, the Senior Historic Environment Advisor at Warwickshire County Council (the Curator) considered that the proposed development had the potential to impact finds, features or deposits of archaeological significance and requested a phase of archaeological evaluation trenching in order to determine the archaeological potential of the Site in accordance with paragraph 205 of the National Planning Policy Framework (MHCLG 2025).

67no. trenches, were excavated over the 9.7ha site, representing a sample size of 4% coverage within the overall proposed development area. The trenches were divided across 3no fields. Field 1, 2 and 3.

The archaeological evaluation largely confirmed the results of the geophysical survey with the most prolific evidence revealing the presence of probable roundhouses, pits and ditches within Trenches 1, 2, 5, 14, 18, 21 – 23 in Field 1 at the northern extent of the Site. The form of the features, and geophysical survey plan, suggest that the north portion of the Site was occupied by a multi-phase, farmstead settlement comprising paddocks, a drove-way and roundhouses with dating evidence recovered from Trenches 2, 6 and 10 suggesting a late Iron Age to Roman date of occupation.

In addition, Late Neolithic domestic activity on the Site was characterised by a series of discrete pits in Trenches 5 and 25, containing Middle and Late Neolithic pottery. Although the pits hint at localised Neolithic domestic occupation, the form of any possible settlement could not be confidently determined within the confines of either trench and was not identifiable within the geophysical survey. Late Bronze Age activity was also revealed at the north-western portion of the Site and was characterised by a series of small pits and a possible cremation, which remained unexcavated, in Trench 10. It is also worth noting that a circular anomaly, identified during the geophysical survey, was targeted by Trench 28, which confirmed the presence of a circular ditched feature which was tentatively interpreted as a possible barrow due to the form of the feature and the presence of mortuary activity 50m to the north. This interpretation should be treated tentatively however as no mortuary deposits or dating evidence was recovered from the trench.

Post-medieval activity was recorded across the Site and largely defined by northeast to southwest aligned furrow troughs in Fields 1 and 2 and northeast to southwest aligned furrow troughs in Field 3 to the east. The form and spacing of the furrows was indicative of post-medieval ridge and furrow cultivation terraces and appeared to be orientated with the sloping topography in order to assist with

drainage of water down-slope in each respective field. An undated ditch extending northwest to southeast across Trenches 1-, 25, 26 and 33 in Field 1 was tentatively assigned a post-medieval date due to the composition of the ditch fills, although no dating evidence was recovered from the feature and no corresponding boundary was present within the historic mapping.

In summary, the evaluation confirmed the presence of disparate Late Neolithic domestic activity, Late Bronze Age mortuary activity and a multi-phase Late Iron Age and Roman farmstead settlement focused within Field 1.

Site conditions were generally poor due to inclement weather, flooding and mixed geology. These aforementioned conditions were not conducive to the best identify the presence or absence of archaeological features and it is not unreasonable to assume that more ephemeral features may have been missed. That said, the broad concentration of features revealed does assist in determining the nature, density and distribution of archaeological features on the Site and does provide an accurate characterisation of the development site as a whole.

Report

1 Introduction

1.1 Background to the project

During late winter 2026, an archaeological evaluation was undertaken at land southwest of Clifton Upon Dunsmore, Warwickshire (the Site). The project was commissioned by Tom Linington, Principal Heritage Planner at Marrons Planning on behalf of Richborough Estates Ltd, in support of a planning application for a proposed residential development of the Site.

A recent geophysical survey on the Site, undertaken by Curae Terrae in 2025, identified a series of anomalies in the northern portion part of the Site which were consistent with late prehistoric or Romano-British settlement activity as well as ring ditches and a possible prehistoric pit alignment. An aerial photographic survey of the Site also identified a series of cropmarks consistent with a sub-rectangular enclosure of probable late prehistoric or Roman provenance.

Accordingly, the Senior Historic Environment Advisor at Warwickshire County Council (the Curator) considered that the proposed development had the potential to impact finds, features or deposits of archaeological significance and requested a phase of archaeological evaluation trenching in order to determine the archaeological potential of the Site in accordance with paragraph 205 of the National Planning Policy Framework (MHCLG 2025).

No brief for the evaluation was provided but a written scheme of investigation (WSI) was prepared by Worcestershire Archaeology (WA 2026) and approved by the Consultant and Curator. The evaluation also conforms to the industry guidelines and standards set out by the Chartered Institute for Archaeologists in *Standard for archaeological field evaluation* (CIfA 2023a) and *Universal guidance for archaeological field evaluation* (CIfA 2023b)

1.2 Site location, topography and geology

The Site encloses an area measuring c. 9.7ha in size, comprised of two agricultural fields, and is situated approximately 1km south of the village of Clifton-upon-Dunsmore, and 4km northeast of Rugby, Warwickshire. The Site is bounded by trees, hedgerows and fencing on all sides. A residential area is located beyond the Sites western border, with further arable land present to the north, south and east.

In terms of topography, the Site has a gentle south facing slope which descends from a height of 114m above Ordnance Datum (aOD) in the north, to a height of approximately 104 m aOD in the south.

The underlying geology of the Site is recorded to consist of Charmouth Mudstone formation. Superficial deposits are recorded as Dunsmore Gravel (British Geological Survey 2026 - Geology of Britain viewer, <https://geologyviewer.bgs.ac.uk/> accessed: 26th February 2026).

2 Archaeological and historical background

2.1 Introduction

The findings for a local HER search of the area, reproduced within the recent geophysical survey by Cura Terrae (Fay, 2025), are summarised below.

2.2 Prehistoric/Iron Age/Roman

A potentially prehistoric, circular earthwork has been identified c. 326 m south of the Site and was revealed during an archaeological excavation of a Radio Mast (HHER MWA12406) (Fay 2025).

Furthermore, undated cropmarks, of possible prehistoric date, have also been identified by aerial photography to the west and northwest of Fields 2 and 3 (WARWSMR-4162 0.5km west; WARWSMR-4163 1km northwest). Two sub-rectangular enclosures, identified as cropmarks, have also been revealed in the northeastern portion of Field 1, and have been interpreted as evidence of late prehistoric or Roman period enclosure (WARSMR - 4164). Both enclosures were recorded and interpreted by geophysical survey as evidence for a multi-phase site of Iron Age date, as discussed below in section 2.5 (Fay, 2025).

2.3 Medieval

A possible watermill which is suggested by documentary evidence is located c. 182m east of the survey area (HHER MWA4155). An Ordnance survey map of 1887 showed a medieval settlement, located c. 570m northeast of the Site (HHER MWA9507) (Fay 2025).

2.4 Post-Medieval/Modern

The site of the Rugby Loop line and viaduct which was built in the late 19th century. The viaduct was marked on an Ordnance survey map of 1886 and is located c. 126 m south of the Site (HHER MWA6917) (Fay 2025).

2.5 Previous archaeological work on the site

No intrusive archaeological works have previously taken place on the Site. A geophysical survey of the Site was carried out by Cura Terrae Ltd during September 2025 (Fay, 2025). The executive summary of the report is provided below for reference:

Cura Terrae were instructed by Marrons Planning on behalf of Richborough to undertake an archaeological geophysical survey on land southwest of Clifton Upon Dunsmore, Warwickshire.

The survey was conducted in September 2025, produced good data throughout and revealed multiple anomalies of a probable archaeological origin. A series of anomalies present in the northeast of Field 1 has been interpreted as representing a likely multi-phase network of interconnected linear ditches, enclosures, and ring-ditch features of likely Iron Age/Romano-British origin.

A small number of further anomalies of potential archaeological origin have also been highlighted, again within Field 1. These anomalies relate to a possible pit alignment, a potential former boundary ditch feature, and an additional proposed albeit more tentative ring-ditch feature, as well as a small number of further anomalies labelled as uncertain trends.

A former boundary visible on 19th century Ordnance Survey (OS) maps of the Site is present within Field 1. Extensive historical cultivation has been identified which has been interpreted as evidence of ridge and furrow based on the morphology of the trends.

Other anomalies present within the dataset indicate localised geological variation and varying quantities of modern ferrous material debris dispersed across the Site that is likely to be associated with recent and modern agricultural activity (Fay, 2025, 4).

3 Project aims

The aims and scope of the Project were to undertake sufficient fieldwork to:

- determine the presence or absence of archaeological deposits beyond reasonable doubt;
- identify their location, nature date and preservation;
- assess their significance;
- assess the likely impact of the proposed development.

The recent geophysical survey, suggested that the Project was liable to encounter remains of Bronze Age, Late Iron Age and/or Roman date and had particular potential to address the following areas of

research as identified in *The archaeology of the West Midlands: a framework for research* (Watt, S (ed) 2011) as follows below:

- 3.2.5 Bronze Age to Iron Age: Processes of Change – Settlement and agriculture (p.117)
- 4.2.2 Roman: Agriculture (p.131)
- 4.3.1 Diet and definition (p.136)

4 Project methodology

A Written Scheme of Investigation (WSI) was prepared by Worcestershire Archaeology (WA 2026). Fieldwork was undertaken between the 19th January 2026 and 6th February 2026.

67no. trenches, amounting to 2,010m² in area, were excavated over the 9.7ha site, representing a sample coverage of 4% of the overall proposed development area. The location of the trenches is indicated in Figure 2.

The trenches were laid out in a broad grid array and positioned to interrogate specific geophysical anomalies and apparent geophysically 'blank' areas of the Site.

Trenches were also positioned to avoid ecological and live service constraints, with the appropriate exclusion zones adhered to.

Deposits considered not to be significant were removed under constant archaeological supervision using a 360° tracked excavator, employing a toothless bucket. Subsequent excavation was undertaken by hand. Clean surfaces were inspected and selected deposits were excavated to retrieve artefactual material and environmental samples, as well as to determine their nature. Deposits were recorded according to standard Worcestershire Archaeology practice (WA 2012) and trench and feature locations were surveyed using a GNSS device with an accuracy limit set at <0.04m. On completion of excavation, trenches were reinstated by replacing the excavated material.

All fieldwork records were checked and cross-referenced. Analysis was undertaken through a combination of structural and rapid assessment of artefactual evidence, allied to the information derived from other sources for the interim. Environmental analysis from sampled features and detailed analysis of the finds will be produced in a final report.

The project archive is currently held at the offices of Worcestershire Archaeology. Subject to the agreement of the landowner it is anticipated that it will be deposited at Warwickshire Museum.

5 Archaeological results

5.1 Introduction

The features recorded in the trenches are shown in Figures 3-15, with photographs and sections also provided. The trench and context inventory is presented in Appendix 1. The results are provided by Field and trench number below.

5.2 Trench descriptions

By Graham Arnold and Peter Lovett

5.2.1 Natural deposits across the site

The natural substrate comprised an orangey-brown sand and gravel and was recorded at an average depth of 0.60m below present ground level in all of the excavated trenches. The natural substrate is consistent with superficial deposits of Dunsmore Gravel as described by the British Geological Survey (BGS, 2026). The natural substrate was overlain by superimposed topsoil and subsoil deposits measuring an average 0.60m in depth,

5.2.2 Blank trenches

In Field 1, Trenches 11 to 13, 15, 27, 29, 31 and 32, 35 to 41, 43 to 46, 48 and 49 were all archaeologically sterile aside from furrow troughs. In addition, none of the trenches within Fields 2 and 3 (52 to 67) contained any other finds, features or deposits of archaeological significance,

5.2.3 Field 1 features

Trench 1 (*Figure 4*)

Two ditches extended west-northwest to east-south-east across Trench 1, with ditch 103 cutting the earlier feature 105 on its northern edge. Both were filled with sterile brown silty sands, with no datable material recovered. Ditch 105 was the larger, being 0.45m deep and at least 0.8m wide, with the suggestion of a curvilinear shape in plan. Ditch 103 was, in contrast, straight and measured 0.28m deep and 1m wide. Both had U-shaped profiles and are probably iterations of the same enclosure ditch. This corresponds well with the broad curving anomaly identified on the geophysical survey and was also identified in Trenches 2 and 3 to the east.

Two furrows ran roughly north to south along the trench, following the general pattern that was identified on the geophysical survey. Two further potential furrows were aligned northwest to southeast; this was a pattern seen across the eastern side of Field 1.

Trench 2 (*Figure 5*)

Trench 2 contained three linear features and a tree throw pit. Two of the ditches 203/209 were excavated, along with the pit 207. In the southern half of the trench, ditch 203 aligned with the broad curvilinear enclosure ditch from the geophysical survey that was also present in Trench 1 (103/105). Ditch 203 measured 1.4m wide, 0.46m deep and contained two fills. A single sherd of Roman pottery was recovered from the upper fill of ditch 203 (see section 6).

The two remaining linear features, partially characterised by ditch 209, extended northwest to southeast across the northern portion of the trench and ran parallel to each other. Both ditches corresponded to a pair of linear anomalies recorded during the geophysical survey and were interpreted as forming a drove way or trackway. The same drove way ditches were also identified in Trench 8 but were not excavated. Ditch 209 was revealed to be a steep-sided ditch with a rounded bottom. It had two fills, both silty sands from which no artefacts were recovered. The feature measured 1.6m wide and 0.82m deep. The north-eastern edge was uncertain, as a probable animal burrow (211) had disturbed that side of the feature.

Tree throw pit 207 was initially interpreted as a probable pit but was later considered likely to be a tree throw due to irregular sides and shape in plan. No finds were recovered from tree throw 207.

Trench 3

A continuation of ditch 103/105, previously identified in Trenches 1 and 2 also extended across the central portion of Trench 3 but was not excavated. Two parallel east to west aligned linear features were excavated, 303 and 305, but these were interpreted to be furrows of probable post-medieval date.

Trench 4

A small pit and possible ditch terminus were identified in this trench. The pit, 404, was very shallow, only 0.03m deep, filled with a grey silty sand, and around 0.5m across. The ditch terminus, 405, was 0.22m deep and 0.78m wide, with a single fill. No dating evidence was recovered from either feature.

Trench 5 (*Figure 6*)

The southern portion of Trench 5 was bisected by a shallow, northeast to southwest aligned ditch terminus, 503. Terminus 503 measured 0.11m deep, 0.65m wide and contained 70no. sherds of Late Neolithic grooved-ware pottery.

The northern portion of Trench 5 was bisected by the western return of a north to south aligned Roman ditch which extended 100m south of Trench 5 and was excavated in Trenches 6 and 14. Accordingly, as dating evidence and characterisation of the ditch had already taken place in Trenches 6 and 14, the enclosure ditch in Trench 5 remained unexcavated and was only recorded in plan.

Trench 6

The centre of Trench 6 was bisected by a north-south aligned Ditch 603 which measured 1.58m in width, 0.33m in depth and contained a fragment of Late Iron Age or Early Roman pottery (see section 6). Ditch 603 represented a later recut of an earlier ditch 605 which was identifiable below the eastern edge of ditch 603. Ditch 603, and 605, were interpreted as characterising the central western arm of the rectilinear enclosure identifiable in the northeastern portion of Field 1 on the geophysical survey and also identified in Trenches 5 and 14.

A second linear feature, extending parallel to 603 and 605 but located west of the main enclosure ditch was also identified but remained unexcavated.

Trench 7

A small curvilinear gully was recorded at the western extent of Trench 7; 703. The gully was 0.33m wide, 0.23m deep and corresponded with the location of a circular anomaly identified during the geophysical survey. Although no dating evidence was recovered from 703 the form of the gully was considered likely to demarcate the location of a probable small late prehistoric or Romano-British roundhouse, shelter or feed-pen.

Trench 8

The driveway ditches recorded in Trench 2 were also revealed bisecting the central portion of Trench 8. As both ditches had previously been investigated in Trench 2, they remained unexcavated and their location was only recorded in plan. The ditches in Trench 8 corresponded well with the probable driveway bisecting the north-eastern portion of Field 1 recorded during the geophysical survey phase of works.

Trench 9

A single northwest to southeast aligned ditch 904 was recorded in Trench 9. The ditch measured 0.26m wide, 0.26m deep and contained a single, silty fill which was likely deposited by low energy waterborne siltation and erosion of the features sides. No finds or dating evidence was recovered from the ditch 904.

Trench 10 (Figure 7)

A possible cremation 1009 was recorded within the north-eastern portion of Trench 10. The cremation remained unexcavated and was surveyed, sealed and covered with coloured flags during backfilling to the mark location. The cremation was broadly characterised by a charcoal rich fill 1010 which contained fragments of burnt bone. The cremation appeared to have been deposited unurned. An additional discrete, charcoal-rich feature were also revealed south-west of 1009 and was similarly interpreted as a possible cremation. The southwestern portion of Trench 10 was bisected by ditch 1005, a northwest to southeast aligned ditch, measuring 0.48m in width, 0.2m in depth and filled by a single, sterile silt deposit devoid of dating evidence. In addition, a small shallow pit or posthole 1003, containing 9no. fragments of Late Bronze Age pottery, was also excavated c. 4m northeast of ditch 1005.

Trench 14 (Figure 8)

Trench 14 contained a continuation of the western arm of the rectilinear enclosure ditch, recorded as ditch 1405, which was previously identified in Trenches 5 and 6. The feature was recorded in plan and remained unexcavated.

Trench 16

A pair of north to south aligned enclosure ditches were identified at the western and eastern extents of Trench 16. These features remained unexcavated due to excessive water ingress although their location was recorded, and measurements taken in plan. Reference to the geophysical survey indicate that the ditches revealed in Trench 16 formed part of a small, rectilinear paddock or enclosure located within the centre of the wider network of coaxially aligned boundary ditches revealed elsewhere within the northern portion of Field 1. No features were revealed within the interior of the enclosure demarcated by the ditches in Trench 16.

Trench 17

Trench 17 was bisected by a pair of east to west aligned ditches at the northern and southern extents of the trench. Similar to Trench 16, both ditches remained unexcavated due to water ingress. However, reference to the geophysical survey indicated that both of the ditches in Trench 17 corresponded well with a pair of linear anomalies in this area and likely demarcated a second, small paddock or enclosure at the eastern portion of Field 1 which was set within the wider network of coaxially aligned ditches revealed elsewhere on the Site.

Trench 18 (Figure 9)

Trench 18 was also excavated in similarly wet conditions, however, water ingress was sufficiently slow enough to allow for the excavation of a single north to south aligned ditch 1804 at the eastern portion of the trench. Ditch 1804 measured 0.28m in width, 0.20m in depth and contained a single sandy fill devoid of dating evidence. Ditch 1804 corresponded with a linear anomaly forming a boundary ditch extending north from the enclosure revealed in Trench 17.

Trench 19

A single, ditched feature 1905 was also revealed in the central portion of Trench 19. Ditch 1905 extended across Trench 19 on a northwest to southeast alignment and measured 0.24m in width, 0.20m in depth and contained a single sandy fill. Ditch 1905 demarcated a boundary extending southeast from the southern arm of the central enclosure revealed in Trench 16.

Trench 21 (Figure 10)

Trench 21 was sited across the location of 2no. enclosure ditches and a curvilinear anomaly consistent with a roundhouse structure. A single, unexcavated, east-west aligned ditch was recorded within the northern portion of the trench and a second north-east to southwest orientated enclosure ditch was recorded within the southern portion of Trench 21. Given the disparate orientation of both enclosure ditches, in contrast to the other coaxially aligned linears revealed on the Site, the 2no. ditches in Trench 21 were considered likely to be associated with separate phases of occupation. The central portion of Trench 21 contained a northern and southern return of a curvilinear gully, almost certainly demarcating the location of a roundhouse. Only the northern arm of the gully was excavated 2103, and the form was consistent with a possible roundhouse gully or wall construction trench. No finds were recovered from gully 2103.

Trench 22 (Figure 11)

Trench 22 was sited across the southern portion of the misaligned, enclosure recorded within Trench 21. The trench contained two northwest-southeast aligned ditches 2205/2209 together with a shallow post-hole 2203 and further examples of post-medieval furrowing across the site 2207/2211. No finds were recovered from any of the features revealed within the trench.

Trench 23 (Figure 12)

Two parallel, east to west aligned enclosure ditches 2303/2306 were recorded in the centre of the Trench 23. Ditch 2303, characterised the northernmost of the two ditches and measured 0.37m in width, 0.32m in depth and contained a single silty fill. Ditch 2305 was located 5m to the south, measured 0.20m in width, 0.18m in depth and also contained a single, silty fill. Both features were

devoid of dating evidence and broadly corresponded with the location of a loosely east to west aligned linear anomaly on the geophysics. The excavator considered that both ditches either formed a narrow trackway or flanked a possible upcast bank – since removed by later agricultural activity.

Trench 24

An east-west aligned ditched feature was revealed within the centre of Trench 24, which corresponded with the southern arm of the broad enclosure ditch revealed in Trenches 5, 6, 14 and 23. The feature remained unexcavated due to excessive water ingress but was recorded in plan.

Trench 25 (Figure 13)

A regular oval pit 2505 was revealed within the central portion of Trench 25. Pit 2505 measured 0.47m in width, 0.40m in depth, contained three, superimposed silt deposits containing 4no. fragments of Middle Neolithic Impressed Ware pottery (See section 6). Pit 2505 was located 1m to the north of the post-medieval ditch which extends northwest to southeast across the centre of Field 1 and has been previously excavated in Trenches 10 and 26.

Trench 26 (Figure 14)

Trench 26 was sited across the location of a northwest to southeast aligned linear 2603 which extended across the central portion of the trench. Ditch 2603 measured 0.4m in width, 0.35m in depth and contained a mixed sandy fill devoid of pottery. The ditch was considered likely to be post-medieval in date and was a continuation of the ditched feature revealed in Trenches 10 and 25.

Trench 28 (Figure 15)

Trench 28 was targeted across the location of a 15m wide, circular, ditched anomaly revealed during the geophysical survey phase of works. The central portion of Trench 28 revealed a multi-phase series of curving gullies and ditches which corresponded with the anomaly revealed during the geophysical survey. Both the northern and southern arm of the circular, ditched feature were revealed within the trench although only the southern arm was excavated. The earliest, identifiable feature in the southern arm comprised a curving east to west aligned gully 2807 which was later truncated within its northern, inner edge, by a wider and deeper ditch 2803. Ditch 2803 measured 0.8m wide and contained a series of superimposed, naturally deposited fills extending to a cumulative depth of 0.70m.

The southern edge of curving gully 2807 was truncated by a posthole 2810 which stratigraphically appeared to be loosely contemporary with the later ditch 2803. No finds were recovered from any of the deposits within ditches 2803, 2807 or posthole 2810. Although any interpretation of the features revealed in Trench 28 is hindered by both the absence of finds and the limited confines of the trench it is considered possible that ditch 2803 may partially characterise the southern arm of a barrow ditch which was excavated across either an earlier smaller barrow or, more likely, an earlier roundhouse structure speculated to be of Bronze Age date.

Trench 33 and 34

Shallow ditches or gully termini [3304/ 3404] were recorded in the south end of Trench 33 and west side of Trench 34 continuing out of the trench. Neither of these features were visible on the geophysics, probably due to their shallow nature, similar fills and geological variations across the site. No finds were recovered from the fills.

Trench 39

An irregular, shallow tree throw 3903 was excavated in Trench 39. Tree throw 3903 was irregularly shaped in plan have uneven, irregular sides and measured 0.30m in width and 0.20m in depth. The feature contained a pair of superimposed, well-sorted silt deposits and fragments of intrusive Iron Age pottery.

Trench 42

A single pit 4203, was identified in Trench 42 at the south-eastern portion of Field 1. The pit was ovoid in plan, measured 1.50m in diameter, 0.45m in depth and contained a single, evenly sorted fill. No finds were recovered from pit 4203.

Trenches 30, 47, 50, 52-54 and 58-67

Northeast to southwest aligned post- medieval furrow troughs were recorded in Trenches 30, 47, 50 and 52-54 within Fields 1 and 2. Similarly spaced furrows were also revealed in Field 3 within the south-eastern portion of the Site in Trenches 58-67. However, the furrow troughs in Trenches 58-67 were aligned on a separate northwest to southeast orientation, likely due to being located within both a separate, relict, field to Fields 1 and 2 and in order to take advantage of slightly different sloping topography. The furrows revealed in Fields 1 – 3 all corresponded with the anomalies interpreted as furrows during the geophysical survey.

5.2.4 Modern deposits

The topsoil and subsoil were frequently cut by modern, ceramic, land drains and contained fragments of modern ceramics likely deposited during manuring and agricultural activity on the Site.

6 Artefactual evidence – interim assessment

By Laura Griffin

6.1 Aims

This assessment aimed to sort, spot date, and quantify all artefacts and give a brief overview of the assemblage.

6.2 Methodology

6.2.1 Recovery policy

Artefacts were recovered according to standard Worcestershire Archaeology practice (WA 2012).

The majority of artefacts collected in the field were recovered by hand, but a small quantity of further material was retrieved from environmental samples (see below).

6.2.2 Method of analysis

All hand-retrieved finds were examined. They quantified and where possible, spot-dated to general period. All information was recorded on a Microsoft Access 2007 database, with tables generated using Microsoft Excel.

Artefacts from environmental samples were examined and those worthy of comment are included below.

6.2.3 Discard policy

Artefacts from topsoil and subsoil and unstratified contexts will normally be noted but not retained, unless they are of intrinsic interest (e.g. worked flint or flint debitage, featured pottery sherds, and other potential 'registered artefacts'). Large assemblages of post-medieval or modern material, unless there is some special reason to retain (such as local production), may be noted and not retained, or, if appropriate, a representative sample will be retained. Discard of finds from post-medieval and earlier deposits will only be instituted with reference to museum collection policy and/or with agreement of the local museum.

6.3 Results

The results are summarised in Table 1.

The assemblage totalled 100 finds weighing 735g (see Table 1). Finds came from nine stratified contexts and could be dated from the middle Neolithic period onwards.

trench	context	material class	object specific type	material subtype	count	weight (g)	comments	period
2	205	ceramic	pot		1	19	Small base in fine oxidised fabric	Roman
5	504	ceramic	pot		70	449	Grooved ware	Late Neolithic
6	604	ceramic	pot		1	13	Oxidised, grog-tempered fabric with slightly blackened surface and cordon	?late Iron Age/early Roman
10	1004	ceramic	pot		5	117	Rim, very friable body. Flat topped ovoid/barrel shaped jar with row of fingertipping 2.5cm below rim	late Bronze Age
10	1004	ceramic	pot		4	18	Highly abraded fragments. From sample 2	prehistoric
10	1007	ceramic	pot		4	14	Highly abraded ?base and body	?later prehistoric
10	1008	ceramic	pot		3	4	Oxidised exterior with faint ?lattice	?Roman
25	2502	ceramic	pot		1	11	Impressed ware. From sample 4	middle Neolithic
25	2504	ceramic	pot		3	19	Impressed ware	middle Neolithic
39	3904	ceramic	pot		5	49	Small jar with neck and upright rim. Sandy fabric, black	middle-late Iron Age
39	3904	ceramic	pot		2	3	Fragments of sandy oxidised fabric with small ?rock inclusions. From sample 1.	undated
39	3904	metal	object		1	19	Highly corroded ring - not perfectly round. Unsure of function - ?fitting	undated
					100	735		

Table 1: Quantification of site assemblage by context

6.4 Discussion

The finds formed an interesting assemblage spanning a number of periods. Of particular interest was the presence of a significant quantity Neolithic pottery in the form of Impressed Ware (Trench 25,

contexts 2502 and 2504) and Grooved Ware (Trench 5, context 504). Although abraded, this material was still in good condition and included a number of fairly sizable sherds with well-preserved decoration. Although other assemblages of Neolithic pottery are known from the Rugby area, material of this date is still relatively rare, making this a significant find.

Further prehistoric pottery recovered from other areas of the site, including five sherds from a fairly substantial late Bronze Age jar of ovoid/barrel-shaped form with a flat-topped rim and a roughly formed row of fingertipping approximately 2.5cm below it (Trench 10, context 1004).

Other sherds of note included a small necked jar with an upright rim in a fine sandy fabric fired to black, which was dated to middle-late Iron Age (Trench 39, context 3904) and a body sherd in an oxidised grog-tempered fabric with blackened surfaces and a nicely formed cordon consistent with a later Iron Age/early Roman date.

The only non-pottery find was a highly corroded iron ring (Trench 39, context 3904). This was sub-circular and of unknown function, but likely some sort of fitting. At present it is undated, but it was found alongside the middle-late Iron Age jar described above, so is likely of the same date.

7 Environmental evidence

Environmental sampling was undertaken according to standard Worcestershire Archaeology practice (WA 2012). A list of samples processed from features is provided below. Palaeoenvironmental analysis of the flots and residues will follow in a final report.

Number	Reason	Context	Context title
1	Environmental	3904	Fill - Tree throw [3903]
2	Carbon dating	1004	Fill - Pit [1003]
3	Bulk	504	Fill - Ditch [503]
4	Bulk	2504	Fill - Pit [2505]
5	Bulk	3203	Fill - Pit [3204]

Table 2 : List of samples processed for further analysis (all 10L tubs)

8 Discussion and Conclusions

The archaeological evaluation largely confirmed the results of the geophysical survey with the most prolific evidence revealing the presence of probable roundhouses, pits and ditches within Trenches 1, 2, 5, 14, 18, 21 – 23 in Field 1 at the northern portion of the Site. The form of the features, and geophysical survey plan, suggest that the northern portion of the Site was occupied by a multi-phase, farmstead settlement comprising paddocks, a drove-way and roundhouses with dating evidence recovered from Trenches 2, 6 and 10 suggesting a late Iron Age to Roman date of occupation. The form of the farmstead settlement potentially present at Clifton-upon-Dunsmore is not dissimilar than the multi-phase Middle to Late Iron Age settlement at Coton Park, c. 2.5km north-west of the Site. Coton Park similarly contained multiple rectilinear enclosures, interpreted as nightfolds or livestock compounds, within a wider complex of boundary ditches which bordered a series of roundhouse structures (Chapman 2020).

The evaluation also revealed a scattering of Late Neolithic domestic activity, characterised by a series of discrete pits in Trenches 5 and 25, containing Grooved ware pottery. Although the pits hint at localised Late Neolithic domestic occupation, the form of any possible settlement could not be confidently determined within the confines of either trench and was not identifiable within the geophysical survey. Late Bronze Age activity was also revealed at the north-western portion of the

Site and characterised by a series of small pits and a possible cremation, which remained unexcavated, in Trench 10. It is also worth noting that the circular anomaly, identified during the geophysical survey and targeted by Trench 28, confirmed the presence of a circular ditched feature which was tentatively interpreted as a possible barrow due to the form of the feature and the presence of mortuary activity 50m to the north. This interpretation should be treated tentatively however as no mortuary deposits or dating evidence was recovered from the trench.

Post-medieval activity was recorded across the Site and largely defined by northeast to southwest aligned furrow troughs in Fields 1 and 2 and east to west aligned furrow troughs in Field 3 to the east. The form and spacing of the furrows was indicative of post-medieval ridge and furrow cultivation terraces and appeared to be orientated with the sloping topography in order to assist with drainage of water down-slope in each respective field. An undated ditch extending northwest to southeast across Trenches 1-, 25, 26 and 33 in Field 1 was tentatively assigned a post-medieval date due to the composition of the ditch fills, although no dating evidence was recovered from the feature and no corresponding boundary was present within the historic mapping.

In summary, the evaluation confirmed the presence of disparate Late Neolithic domestic activity, Late Bronze Age mortuary activity and a multi-phase Late Iron Age and Roman farmstead settlement focused within Field 1.

Site conditions were generally poor due to inclement weather, flooding and mixed geology. These aforementioned conditions were not conducive to the best identify the presence or absence of archaeological features and it is not unreasonable to assume that more ephemeral features may have been missed. That said, the broad concentration of features revealed does assist in determining the nature, density and distribution of archaeological features on the Site and does provide an accurate characterisation of the development site as a whole.

9 Project personnel

The fieldwork was led by Peter Lovett ACIfA and Michael Nicholson, PCIfA and, assisted by Chris Crump, PCIfA, Eva Rogers, PCIfA and Alexandra Pieniazek.

The project was managed by Rupert Lotherington, MCIfA. The report was produced and collated by Graham Arnold, PCIfA. Abbie Horton produced the figure illustrations. Specialist contributions and individual sections of the report are attributed to the relevant authors throughout the text.

10 Acknowledgements

Worcestershire Archaeology would like to thank the following for the successful conclusion of the project: Tom Linington, (Marrons Planning) and John Robinson (Senior Historic Environment Advisor to Warwickshire County Council).

11 Bibliography

BGS, 2025 Geology of Britain viewer, <https://geologyviewer.bgs.ac.uk/> Accessed: 26 February 2025

Chapman, A. 2020. *Coton Park, Rugby, Warwickshire: A Middle Iron Age Settlement with Copper Alloy Casting*. Archaeopress.

CIfA, 2014a *Standard and guidance: for collection, documentation, conservation and research of archaeological materials*, Reading: Chartered Institute for Archaeologists, published December 2014, updated October 2020

CIfA, 2014b *Standard and guidance: for the creation, compilation, transfer and deposition of archaeological archives*, Reading: Chartered Institute for Archaeologists, published December 2014, updated October 2020

ClfA 2023a *Standard for archaeological field evaluation*, Chartered Institute for Archaeologists, published December 2023

ClfA 2023b *Universal guidance for archaeological field evaluation*, Chartered Institute for Archaeologists, published December 2023

Fay, M. 2025. Land Southwest of Clifton Upon Dunsmore, Warwickshire: Geophysical Survey Report. Curae Terrae unpublished report no. 25257.

MHCLG 2024 *National Planning Policy Framework*. Ministry of Housing, Communities and Local Government, updated December 2024, London

WA, 2012 Manual of service practice, recording manual, Worcestershire Archaeology Unpubl report **1842**, Worcestershire County Council

WA, 2025 Written Scheme of Investigation Archaeological evaluation on land southwest of Clifton-upon-Dunsmore, Warwickshire, Worcestershire Archaeology Unpubl document Version 1.1 dated 6th January 2026, P7108, Worcestershire County Council

Figures

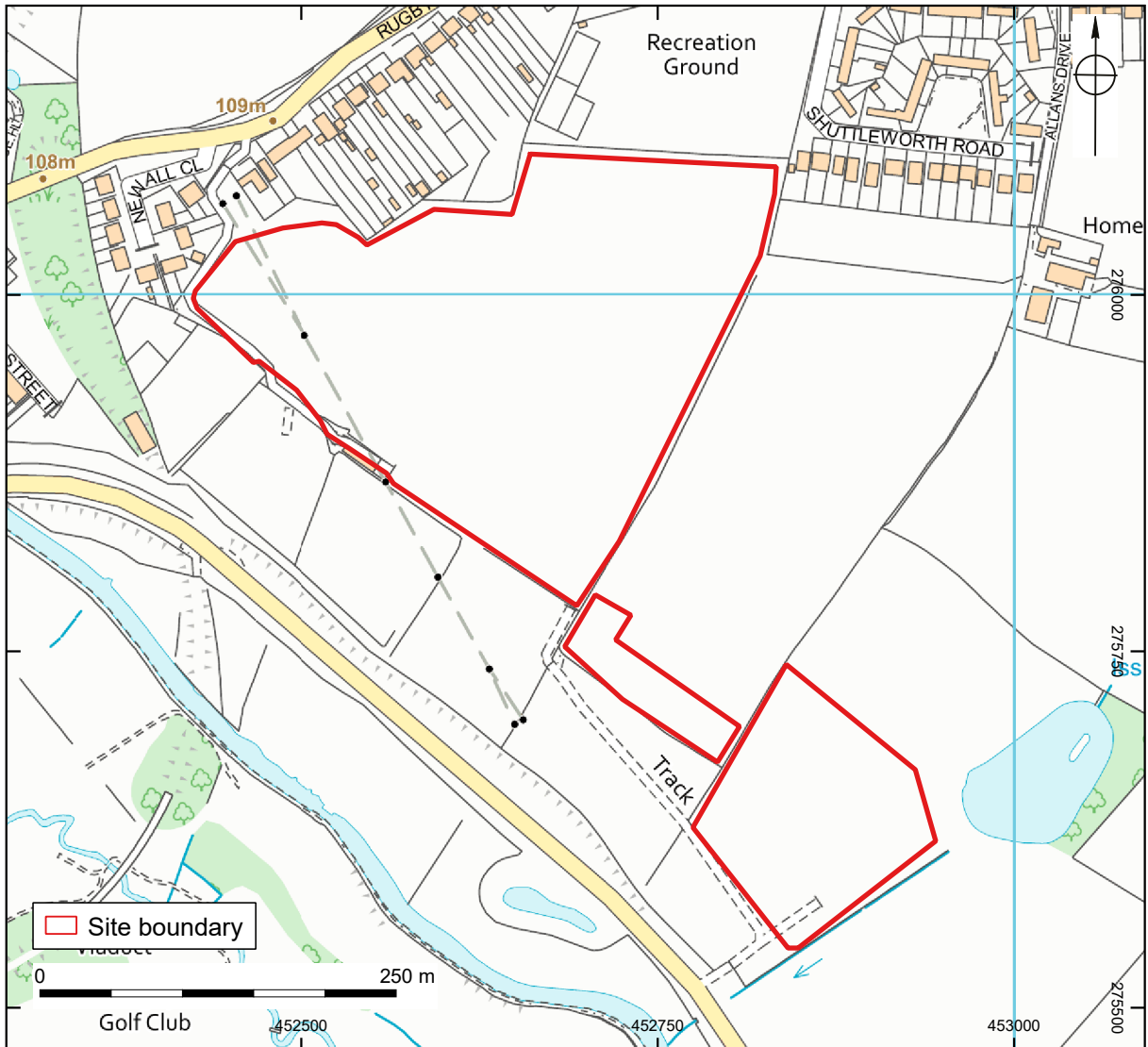

© Crown copyright and database rights 2026 Ordnance Survey AC0000809204
 WA Project number: P7062

scale at A4: 1:5,000

Worcestershire Archaeology
 www.explorethepast.co.uk
 call: 01905 765908
 Part of Worcestershire Archive & Archaeology Service

Figure 1: Location of the site

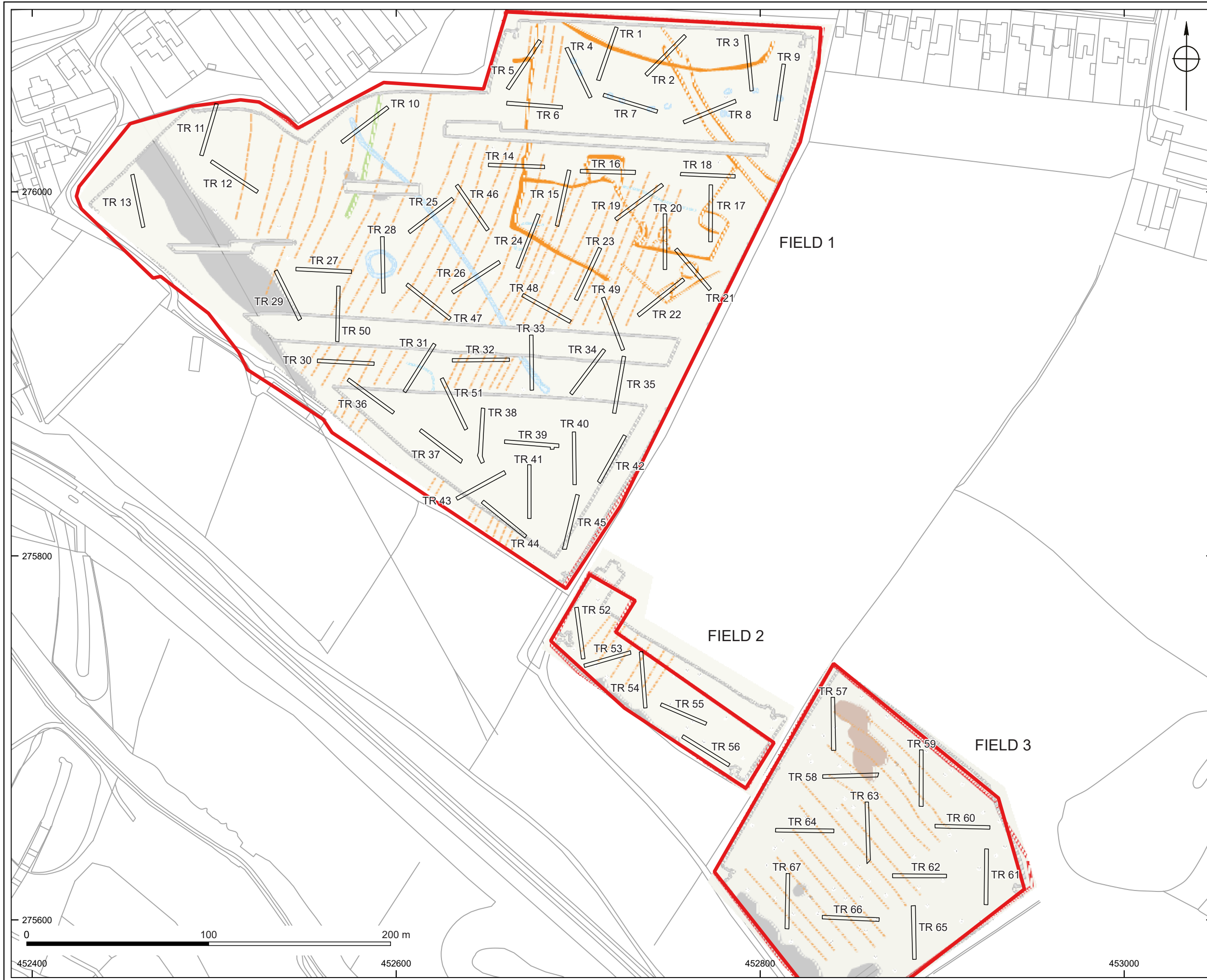

Figure 2
Location of trenches overlaid on geophysics interpretation

- Site boundary
- Edge of trench

Clifton-upon-Dunsmore,
Warwickshire

WA Project number: P7108

26/02/2026

Created by: Horton, Abbie

File path: U:\U160 ACS\U013
Archaeology Service\03 Field
Section\Projects\Current\P7108
Clifton-upon-Dunsmore,
Warwick\07 Site
Data\Survey\Post fieldwork QGIS

Scale at A3: 1:2000

© Crown copyright and database rights
2026 Ordnance Survey AC0000809204.



**Worcestershire
Archaeology**

www.explorethepast.co.uk
call: 01905 765908
Part of Worcestershire Archive & Archaeology Service

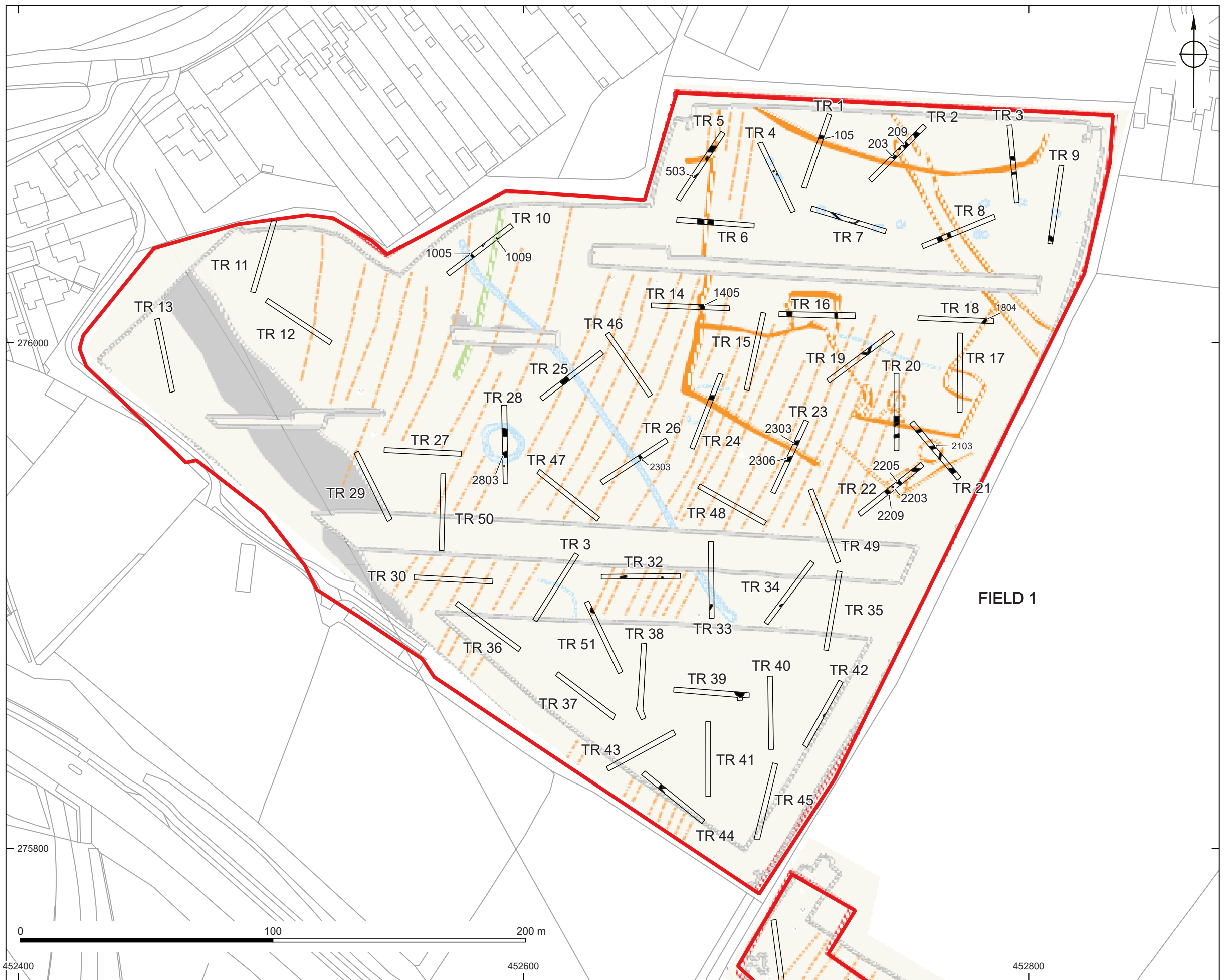

Figure 3

Location of field 1 trenches and features overlaid on geophysics interpretation

- Site boundary
- Edge of trench
- Archaeological feature

Clifton-upon-Dunsmore,
Warwickshire

WA Project number: P7108

26/02/2026

Created by: Horton, Abbie

File path: U:\U160 ACS\U013
Archaeology Service\03 Field
Section\Projects\Current\P7108
Clifton-upon-Dunsmore,
Warwicks\07 Site
Data\Survey\Post fieldwork QGIS

Scale at A3: 1:1500

© Crown copyright and database rights
2026 Ordnance Survey AC0000809204.



www.explorethepast.co.uk
call: 01905 765908
Part of Worcestershire Archive & Archaeology Service

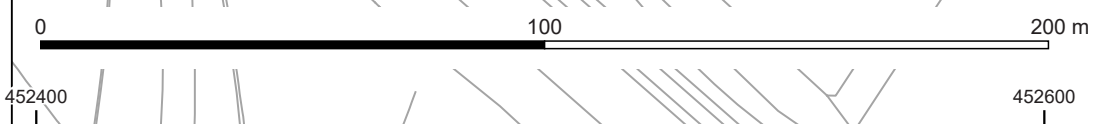

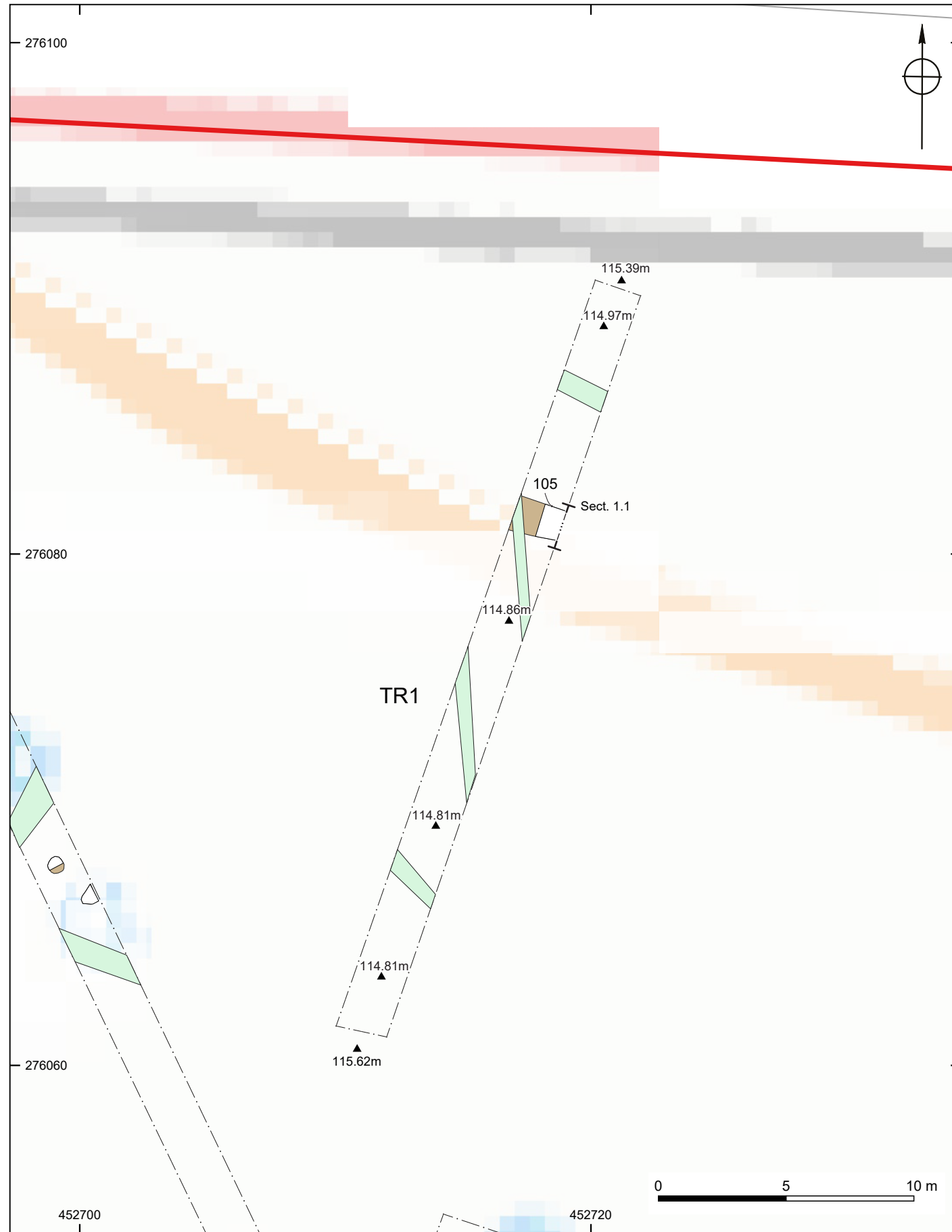

Figure 4.1: Plan of Trench 1



Figure 4.2: Trench 1, facing north, 2x1m scales



Figure 4.3: Ditch 105, facing south-east, 1m scale

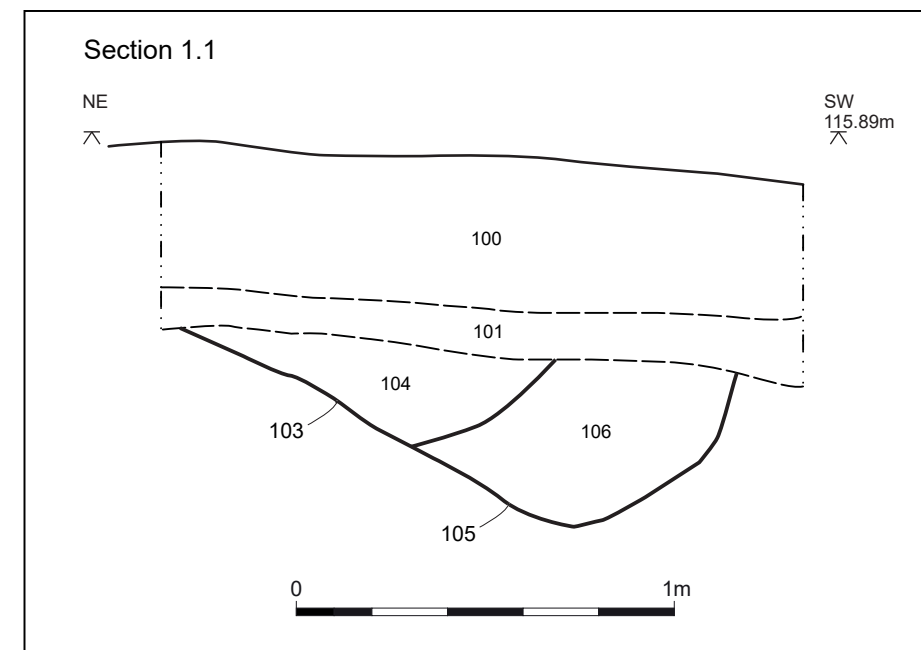

Figure 4.4: Drawing of ditch 105

Figure 4

Trench 1

- Site boundary
- Edge of trench
- Archaeological feature
- Furrow
- Excavated slot
- Section location
- ▲ Spot height

Clifton-upon-Dunsmore,
Warwickshire

WA Project number: P7108

26/02/2026

Created by: Horton, Abbie

File path: U:\U160 ACS\U013
Archaeology Service\03 Field
Section\Projects\Current\P7108
Clifton-upon-Dunsmore,
Warwick\07 Site
Data\Survey\Post fieldwork QGIS

Scale at A3: Plan - 1:200
Section - 1:20



www.explorethepast.co.uk
call: 01905 765908

Part of Worcestershire Archive & Archaeology Service

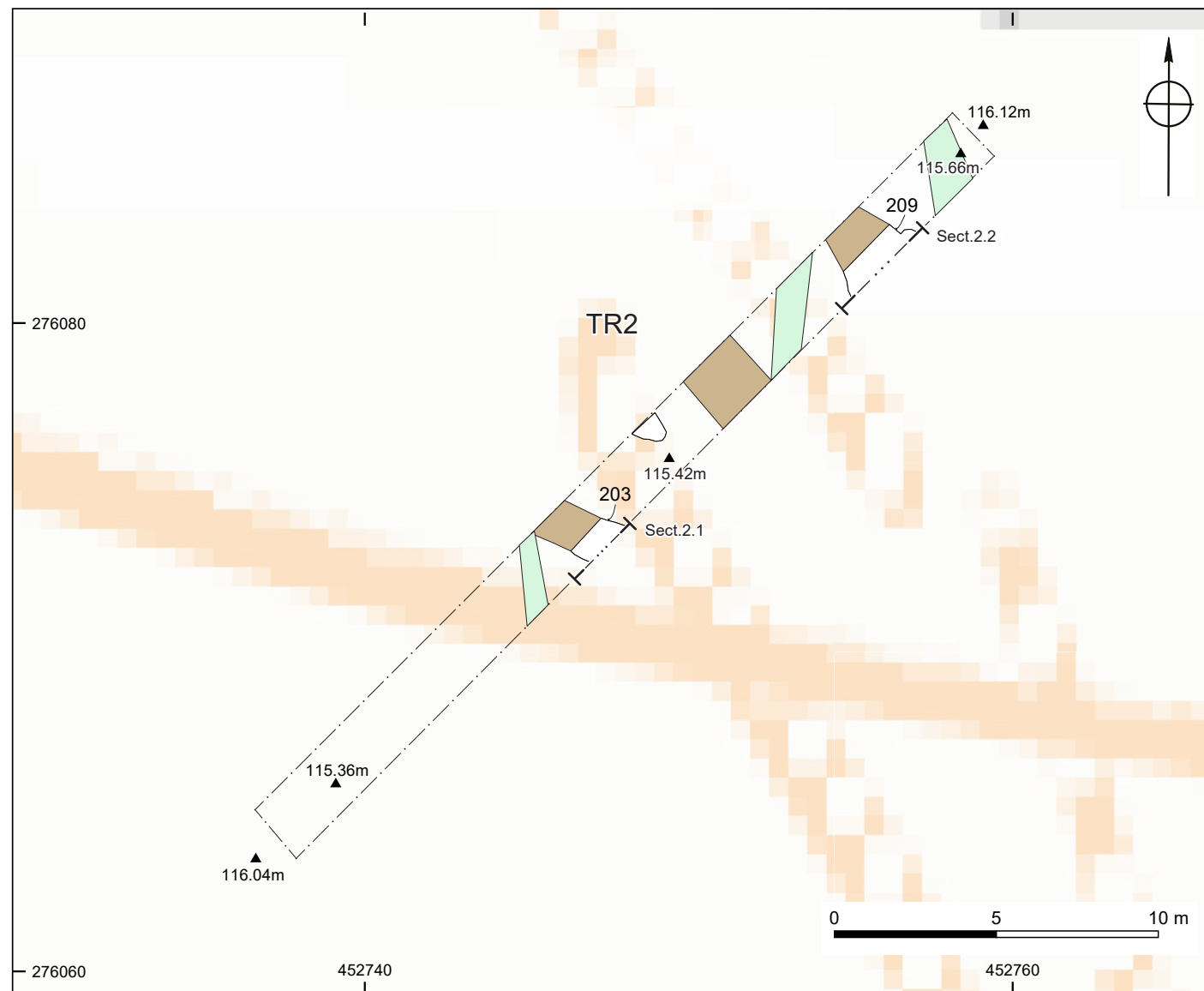

Figure 5.1: Plan of Trench 2

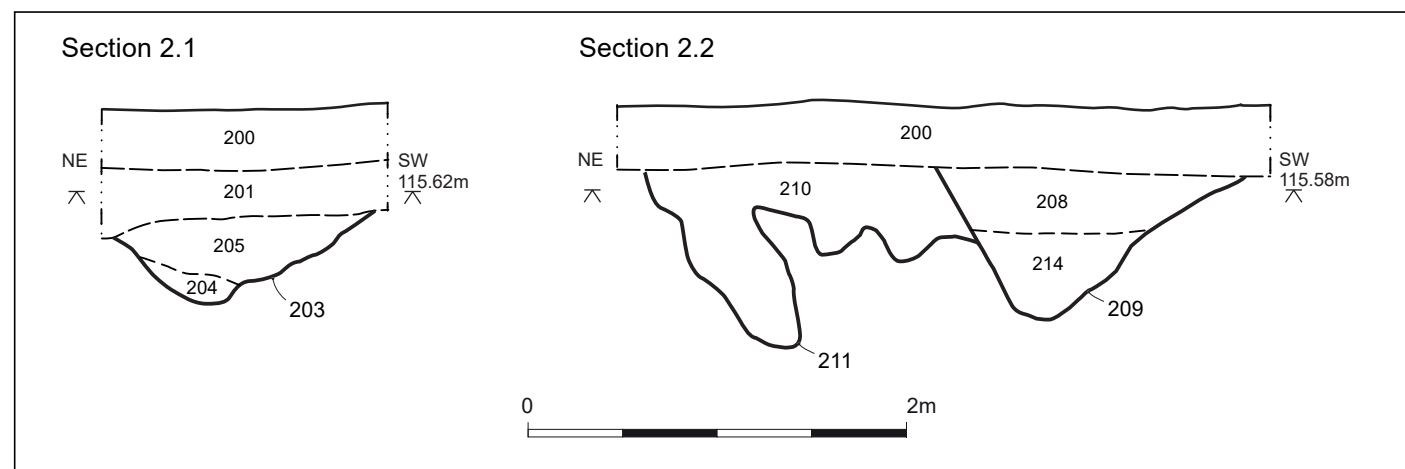

Figure 5.5: Drawings of ditches 203 and 209



Figure 5.2: Trench 2, facing north-east, 2x1m scales



Figure 5.3: Ditch 203, facing south-east, 1m scale



Figure 5.4: Ditch 209, facing south-east, 2x1m scales

Figure 5

Trench 2

- Edge of trench
- Archaeological feature
- Furrow
- Excavated slot
- Section location
- Spot height

Clifton-upon-Dunsmore,
Warwickshire

WA Project number: P7108

26/02/2026

Created by: Horton, Abbie

File path: U:\U160 ACS\U013
Archaeology Service\03 Field
Section\Projects\Current\P7108
Clifton-upon-Dunsmore,
Warwick\07 Site
Data\Survey\Post fieldwork QGIS

Scale at A3: Plan - 1:200
Section - 1:40



www.explorethepast.co.uk
call: 01905 765908

Part of Worcestershire Archive & Archaeology Service

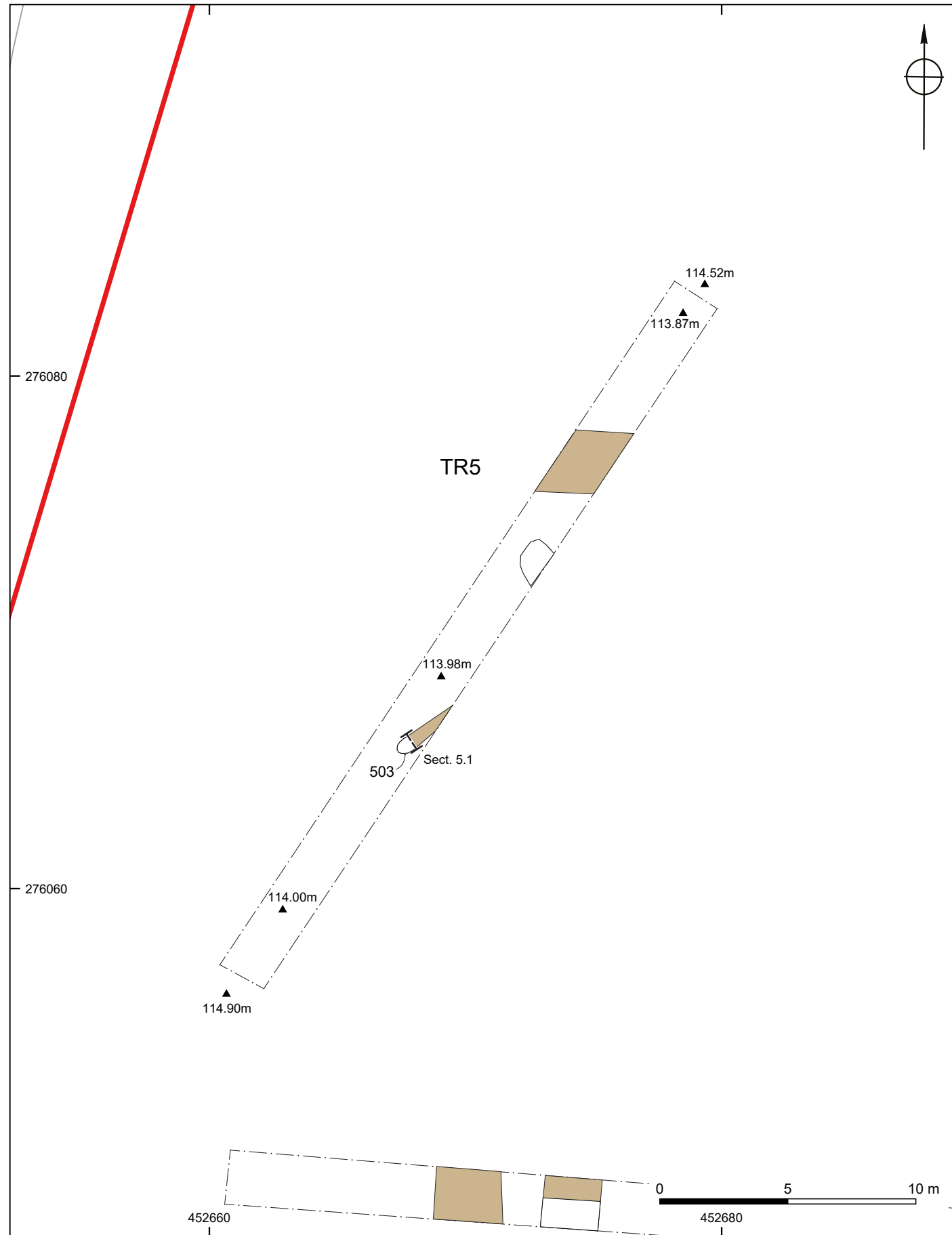

Figure 6.1: Plan of Trench 5



Figure 6.2: Trench 5, facing south-west, 2x1m scales



Figure 6.3: Ditch 503, facing north-east, 0.40m scale

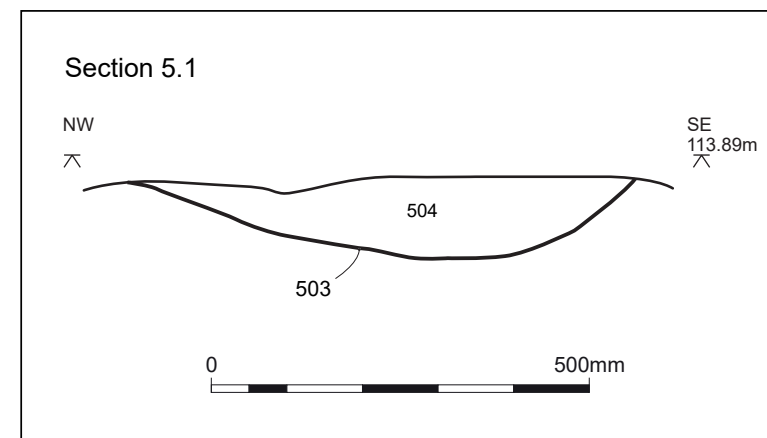

Figure 6.4: Section drawing of ditch 503

Figure 6

Trench 5

- Site boundary
- Edge of trench
- Archaeological feature
- Excavated slot
- Section location
- Spot height

Clifton-upon-Dunsmore,
Warwickshire

WA Project number: P7108

26/02/2026

Created by: Horton, Abbie

File path: U:\U160 ACS\U013
Archaeology Service\03 Field
Section\Projects\Current\P7108
Clifton-upon-Dunsmore,
Warwick\07 Site
Data\Survey\Post fieldwork QGIS

Scale at A3: Plan - 1:200
Section - 1:10



www.explorethepast.co.uk
call: 01905 765908

Part of Worcestershire Archive & Archaeology Service

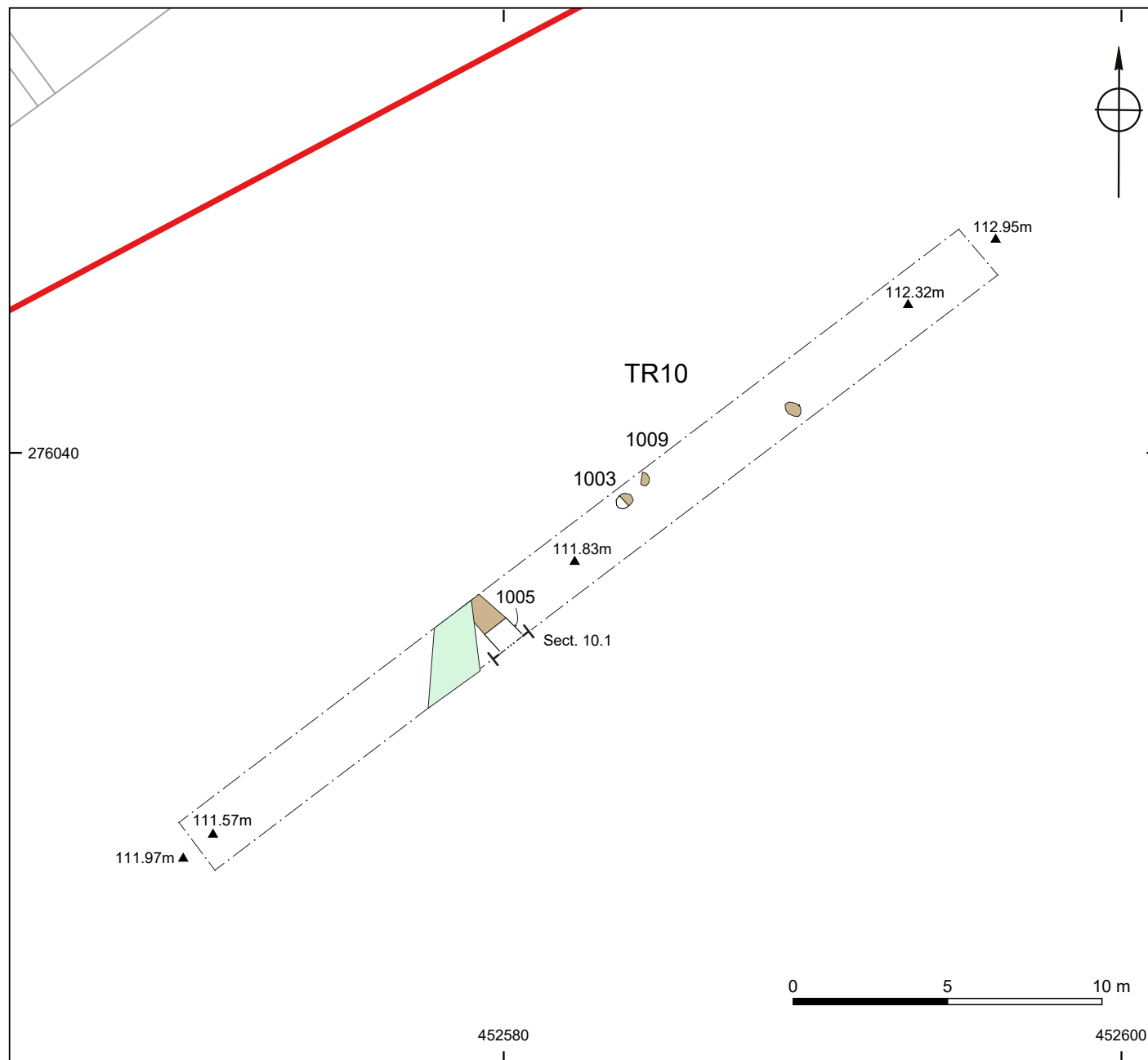

Figure 7.1: Plan of Trench 10



Figure 7.5: Cremation 1009 left and pit 1003, facing south-east, 0.50m scale



Figure 7.2: Trench 10, facing south-west, 2x1m scales



Figure 7.3: Ditch 1005, facing south-east, 1m scale

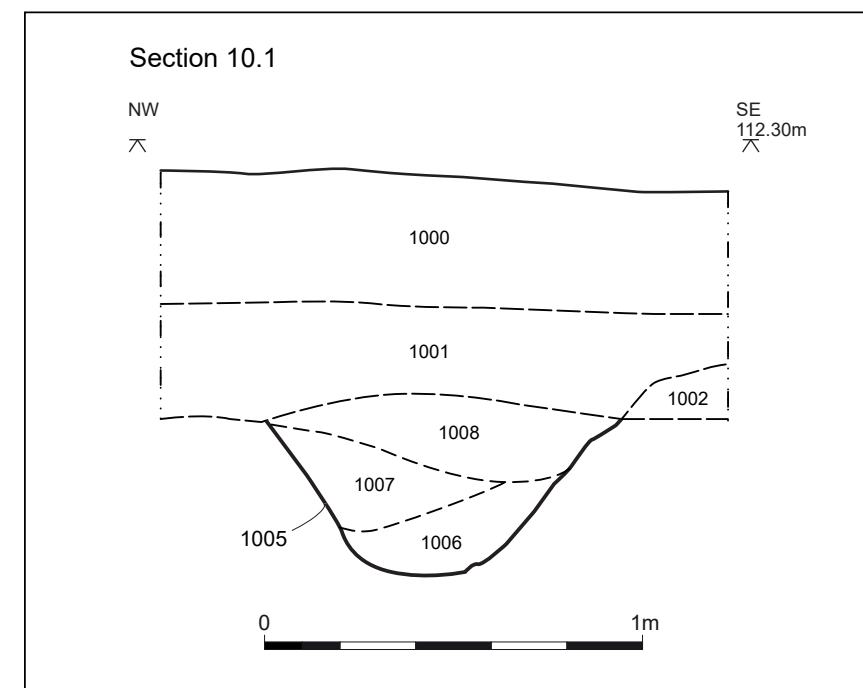

Figure 7.4: Section drawing of ditch 1005

Figure 7

Trench 10

- ▭ Site boundary
- Edge of trench
- Archaeological feature
- Furrow
- Excavated slot
- Section location
- ▲ Spot height

Clifton-upon-Dunsmore,
Warwickshire

WA Project number: P7108

26/02/2026

Created by: Horton, Abbie

File path: U:\U160 ACS\U013
Archaeology Service\03 Field
Section\Projects\Current\P7108
Clifton-upon-Dunsmore,
Warwick\07 Site
Data\Survey\Post fieldwork QGIS

Scale at A3: Plan - 1:200
Section - 1: 20



www.explorethepast.co.uk
call: 01905 765908

Part of Worcestershire Archive & Archaeology Service



Figure 8.1: Plan of Trench 14



Figure 8.2: Trench 14, facing west, 2x1m scales



Figure 8.3: Ditch 1405, facing north, 2x1m scale

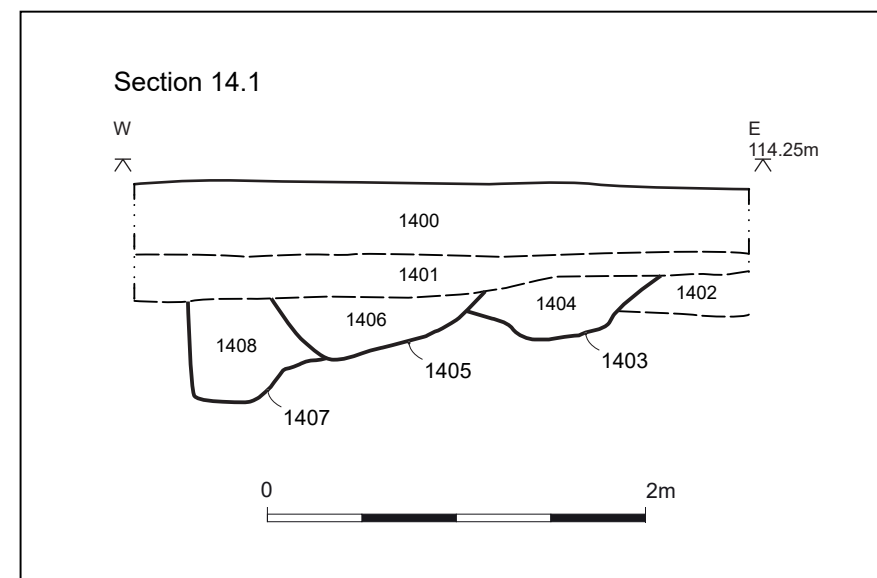

Figure 8.4: Section drawing of ditch 1405

Figure 8
Trench 14

- Edge of trench
- Archaeological feature
- Furrow
- Excavated slot
- Section location
- Spot height

Clifton-upon-Dunsmore,
Warwickshire

WA Project number: P7108

26/02/2026

Created by: Horton, Abbie

File path: U:\U160 ACS\U013
Archaeology Service\03 Field
Section\Projects\Current\P7108
Clifton-upon-Dunsmore,
Warwick\07 Site
Data\Survey\Post fieldwork QGIS

Scale at A3: Plan - 1:200
Section - 1:40



www.explorethepast.co.uk
call: 01905 765908

Part of Worcestershire Archive & Archaeology Service

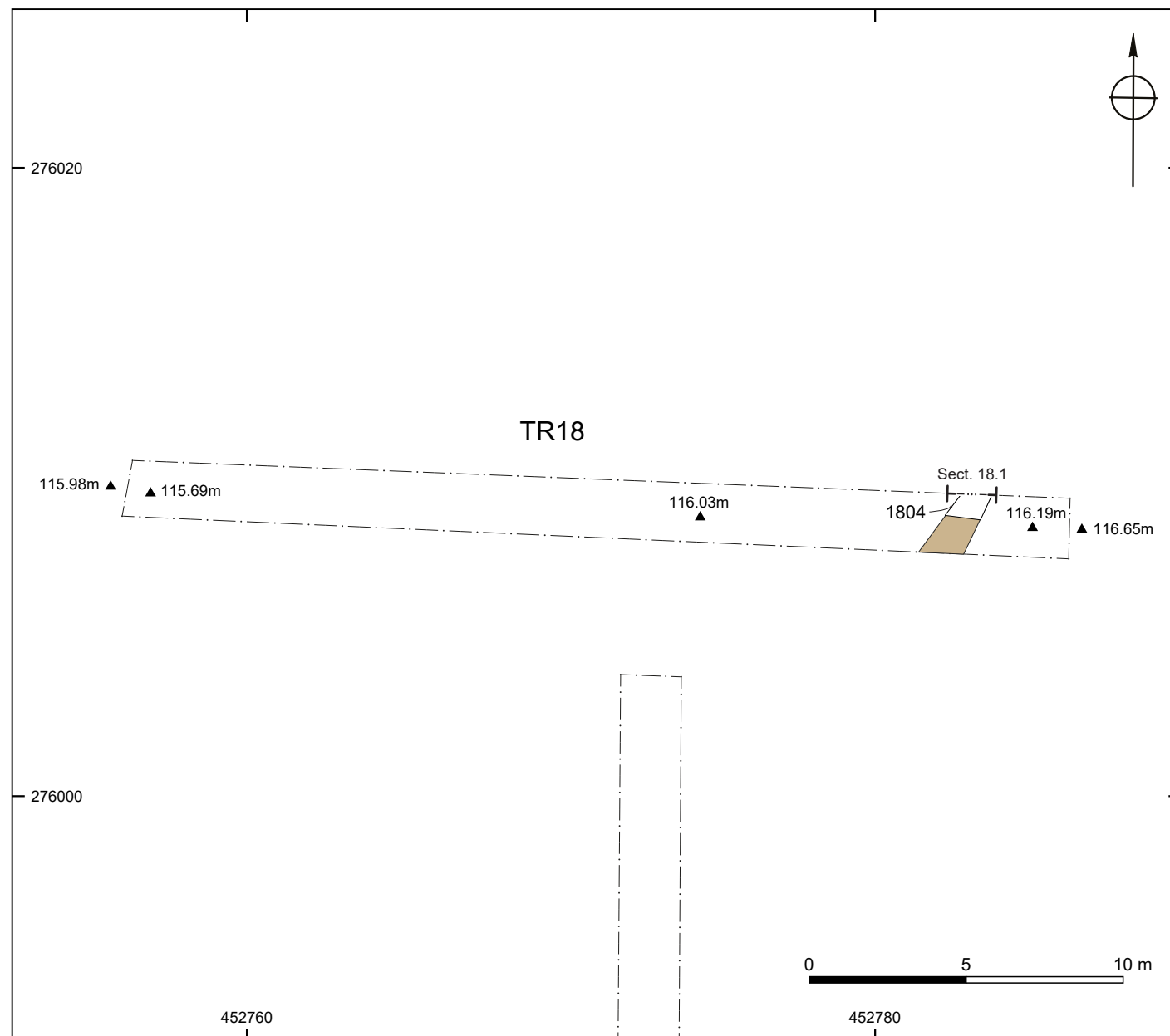

Figure 9.1: Plan of Trench 18



Figure 9.2: Ditch 1804, facing north, 1m scale

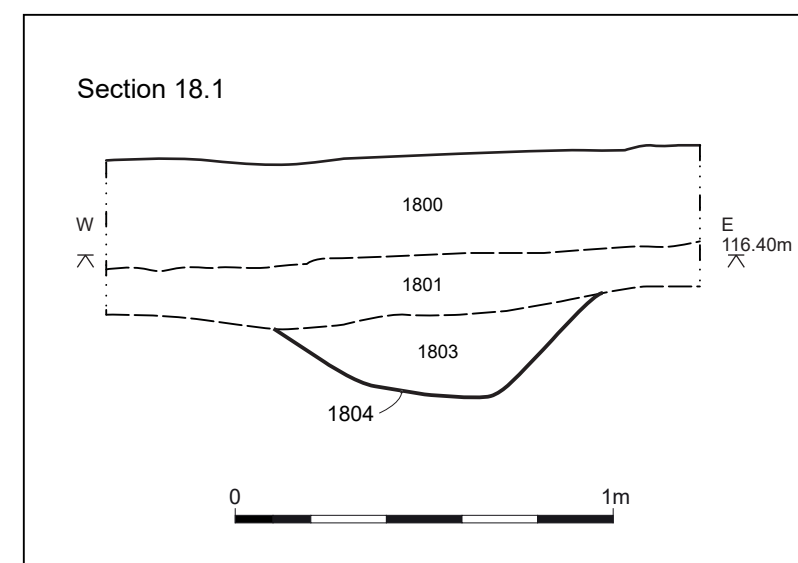

Figure 9.3: Section drawing of ditch 1804

Figure 9
Trench 18

- Edge of trench
- Archaeological feature
- Excavated slot
- Section location
- ▲ Spot height

Clifton-upon-Dunsmore,
Warwickshire

WA Project number: P7108

26/02/2026

Created by: Horton, Abbie

File path: U:\U160 ACS\U013
Archaeology Service\03 Field
Section\Projects\Current\P7108
Clifton-upon-Dunsmore,
Warwicks\07 Site
Data\Survey\Post fieldwork QGIS

Scale at A3: Plan - 1:200
Section - 1:20



www.explorethepast.co.uk
call: 01905 765908

Part of Worcestershire Archive & Archaeology Service

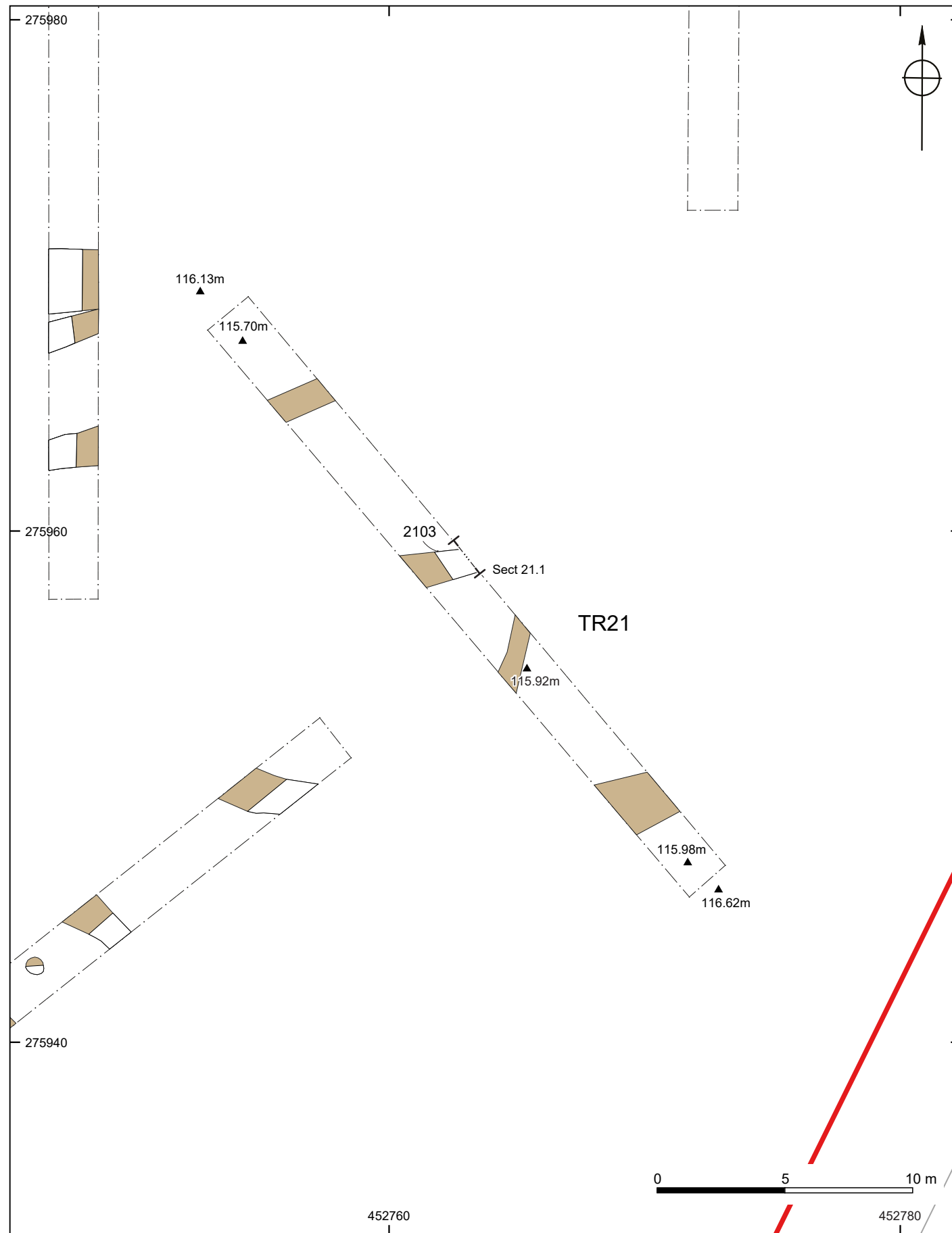

Figure 10.1: Plan of Trench 21



Figure 10.2: Trench 21, facing north-west, 2x1m scales



Figure 10.3: Ditch 2103, facing north-east, 1m scale

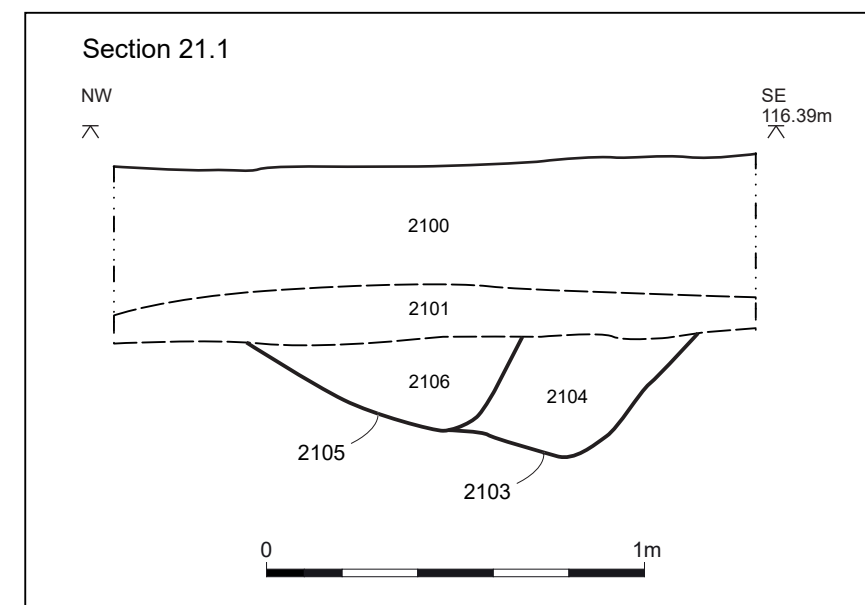

Figure 10.4: Section drawing of ditch 2103

Figure 10

Trench 21

- Site boundary
- Edge of trench
- Archaeological feature
- Excavated slot
- Section location
- Spot height

Clifton-upon-Dunsmore,
Warwickshire

WA Project number: P7108

26/02/2026

Created by: Horton, Abbie

File path: U:\U160 ACS\U013
Archaeology Service\03 Field
Section\Projects\Current\P7108
Clifton-upon-Dunsmore,
Warwick\07 Site
Data\Survey\Post fieldwork QGIS

Scale at A3: Plan - 1:200
Section - 1:40



www.explorethepast.co.uk
call: 01905 765908

Part of Worcestershire Archive & Archaeology Service

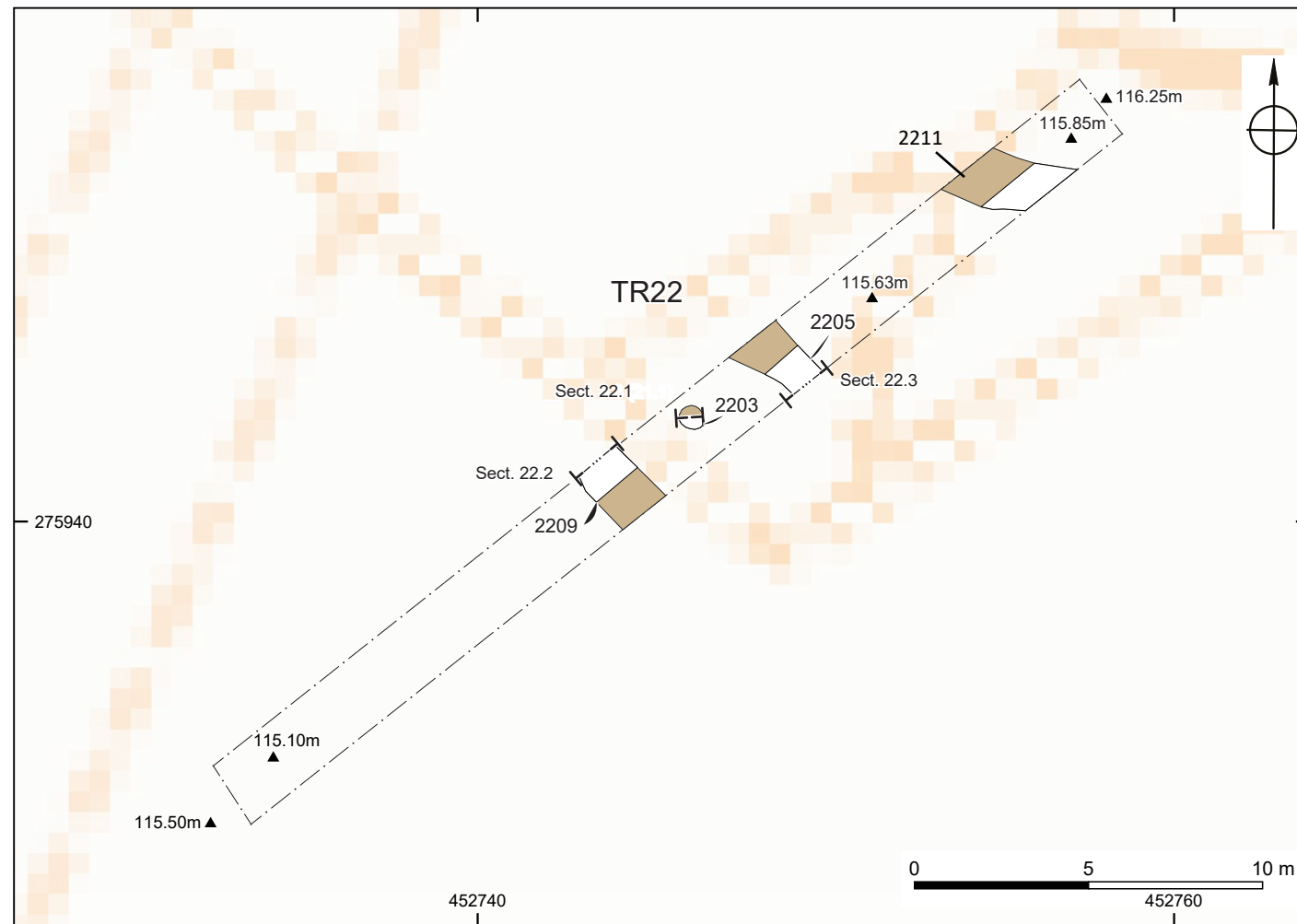

(Left) Figure 11.1: Plan of Trench 22



Figure 11.2: Trench 2, facing north-east, 2x1m scales

Figure 11
Trench 22

- Site boundary
- Edge of trench
- Archaeological feature
- Furrow
- Excavated slot
- Section location
- Spot height



Figure 11.3: Pit 2203, facing north, 0.50m scale



Figure 11.4: Ditch 2205, facing south-east, 1m scale



Figure 11.5: Ditches 2207 and 2209, facing south-east, 2x1m scales

Clifton-upon-Dunsmore,
Warwickshire

WA Project number: P7108

26/02/2026

Created by: Horton, Abbie

File path: U:\U160 ACS\U013
Archaeology Service\03 Field
Section\Projects\Current\P7108
Clifton-upon-Dunsmore,
Warwick\07 Site
Data\Survey\Post fieldwork QGIS

Scale at A3: Plan - 1:200
Section - 1:40

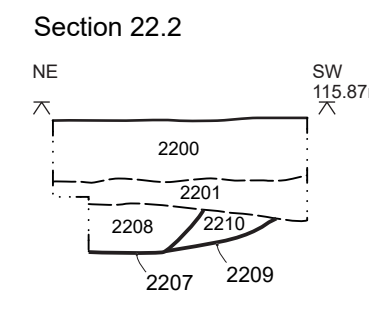
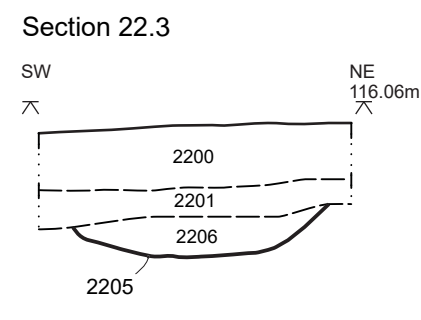
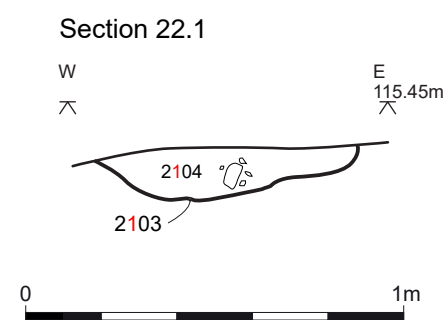
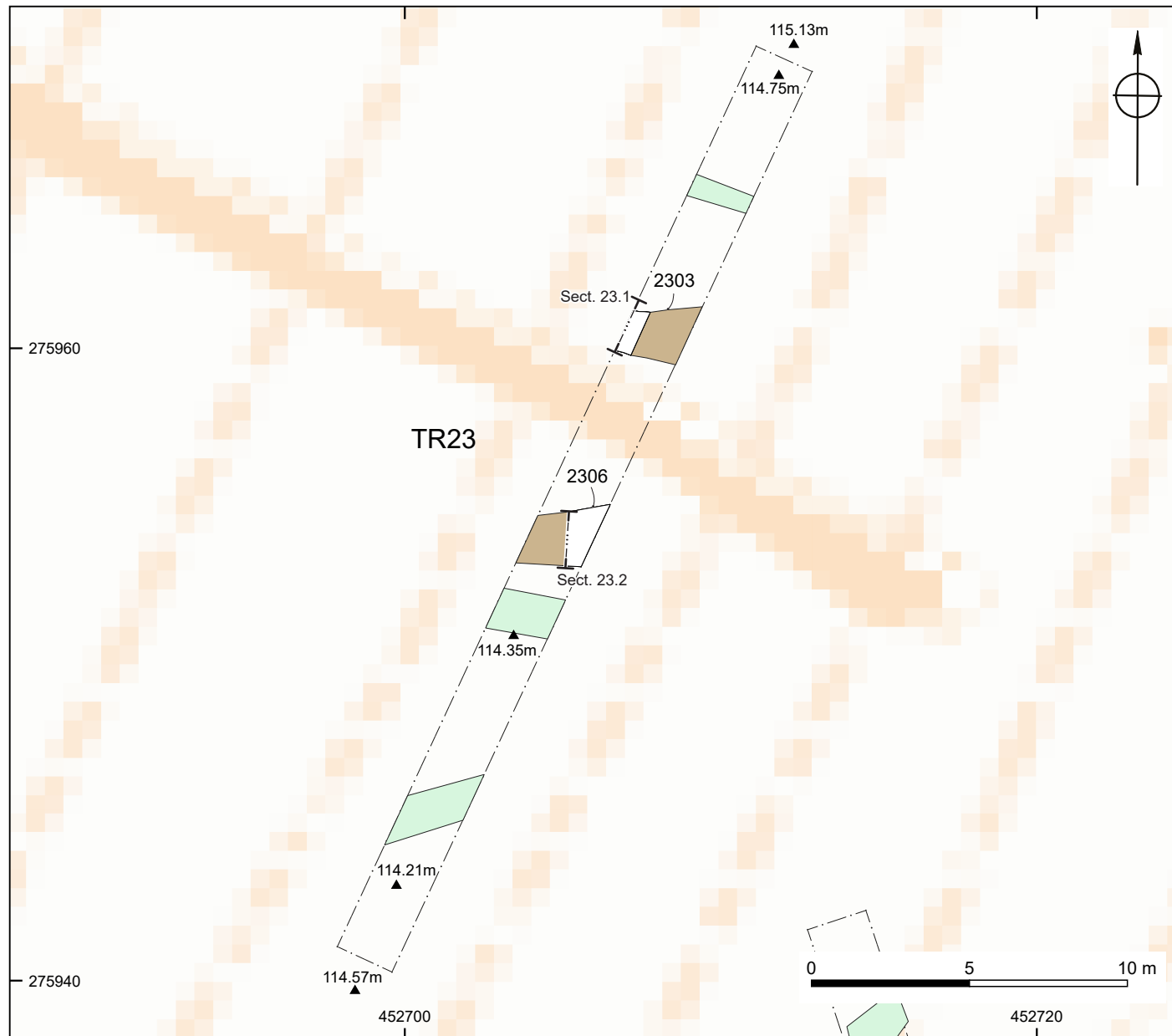

Figure 11.6: Section drawings



www.explorethepast.co.uk
call: 01905 765908

Part of Worcestershire Archive & Archaeology Service



(Above) Figure 12.1:
Plan of Trench 23



(Right) Figure 12.5: Section drawings of ditch 2303 and ditch 2306



Figure 12.2: Trench 23, facing north, 2x1m scale



Figure 12.3: Ditch 2303, facing south-east, 0.50m scale



Figure 12.4: Ditch 2306, facing south-west, 1m scale

Figure 12

Trench 23

- Edge of trench
- Archaeological feature
- Furrow
- Excavated slot
- Section location
- Spot height

Clifton-upon-Dunsmore,
Warwickshire

WA Project number: P7108

02/03/2026

Created by: Horton, Abbie

File path: U:\U160 ACS\U013
Archaeology Service\03 Field
Section\Projects\Current\P7108
Clifton-upon-Dunsmore,
Warwick\07 Site
Data\Survey\Post fieldwork QGIS

Scale at A3: Plan - 1:200
Section - 1:20



www.explorethepast.co.uk
call: 01905 765908

Part of Worcestershire Archive & Archaeology Service

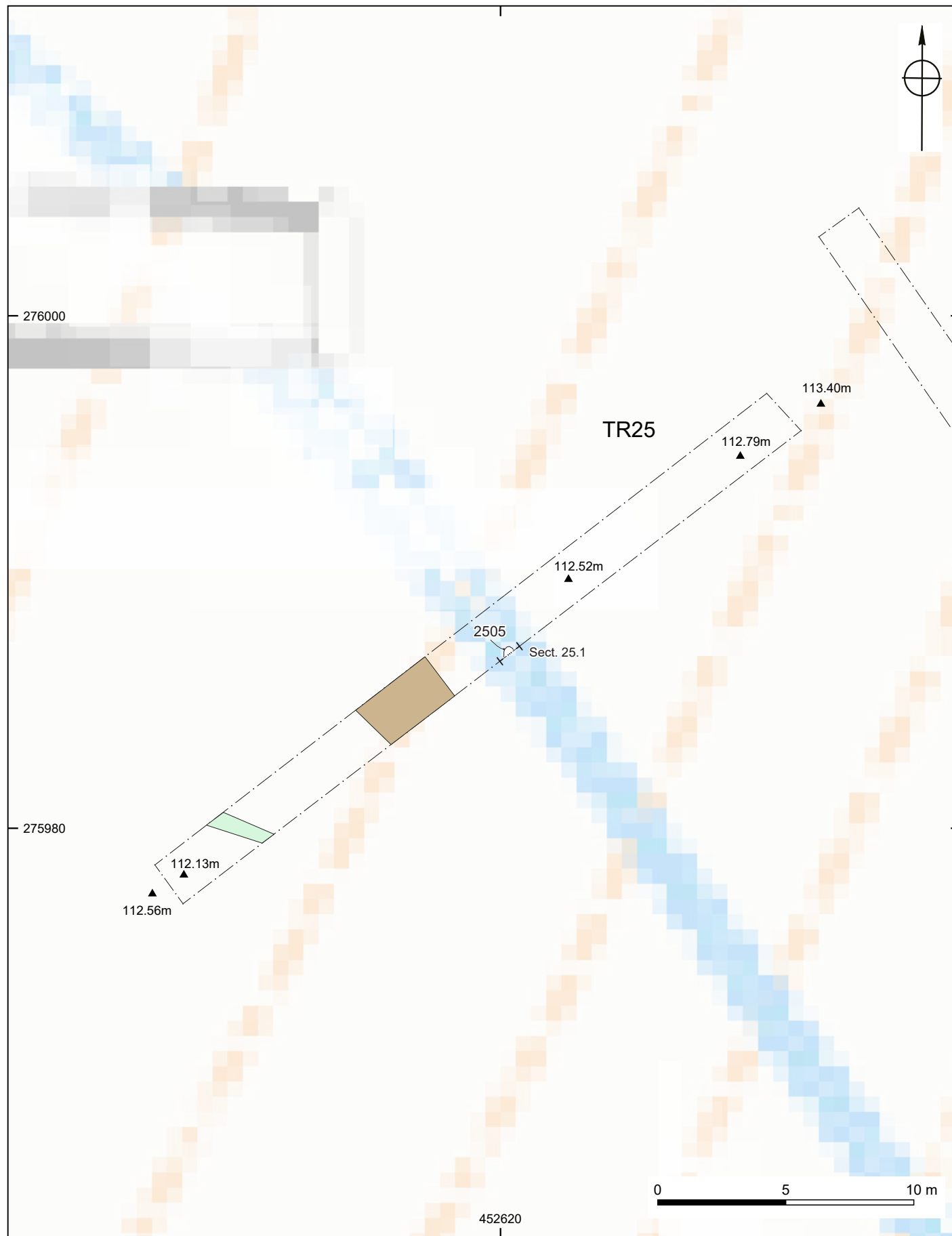

Figure 13.1: Plan of Trench 25



Figure 13.2: Trench 25, facing north-east, 2x1m scales



Figure 13.3: Pit 2505, facing east, 1m scale

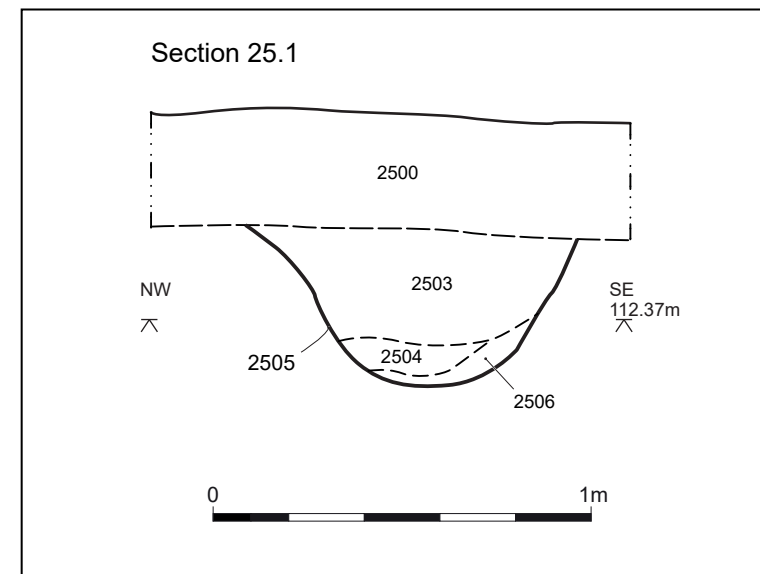

Figure 13.4: Section drawing of pit 2505

Figure 13

Trench 25

- Edge of trench
- Archaeological feature
- Furrow
- Excavated slot
- Section location
- Spot height

Clifton-upon-Dunsmore,
Warwickshire

WA Project number: P7108

27/02/2026

Created by: Horton, Abbie

File path: U:\U160 ACS\U013
Archaeology Service\03 Field
Section\Projects\Current\P7108
Clifton-upon-Dunsmore,
Warwick\07 Site
Data\Survey\Post fieldwork QGIS

Scale at A3: Plan - 1:200
Section - 1:20



www.explorethepast.co.uk
call: 01905 765908

Part of Worcestershire Archive & Archaeology Service

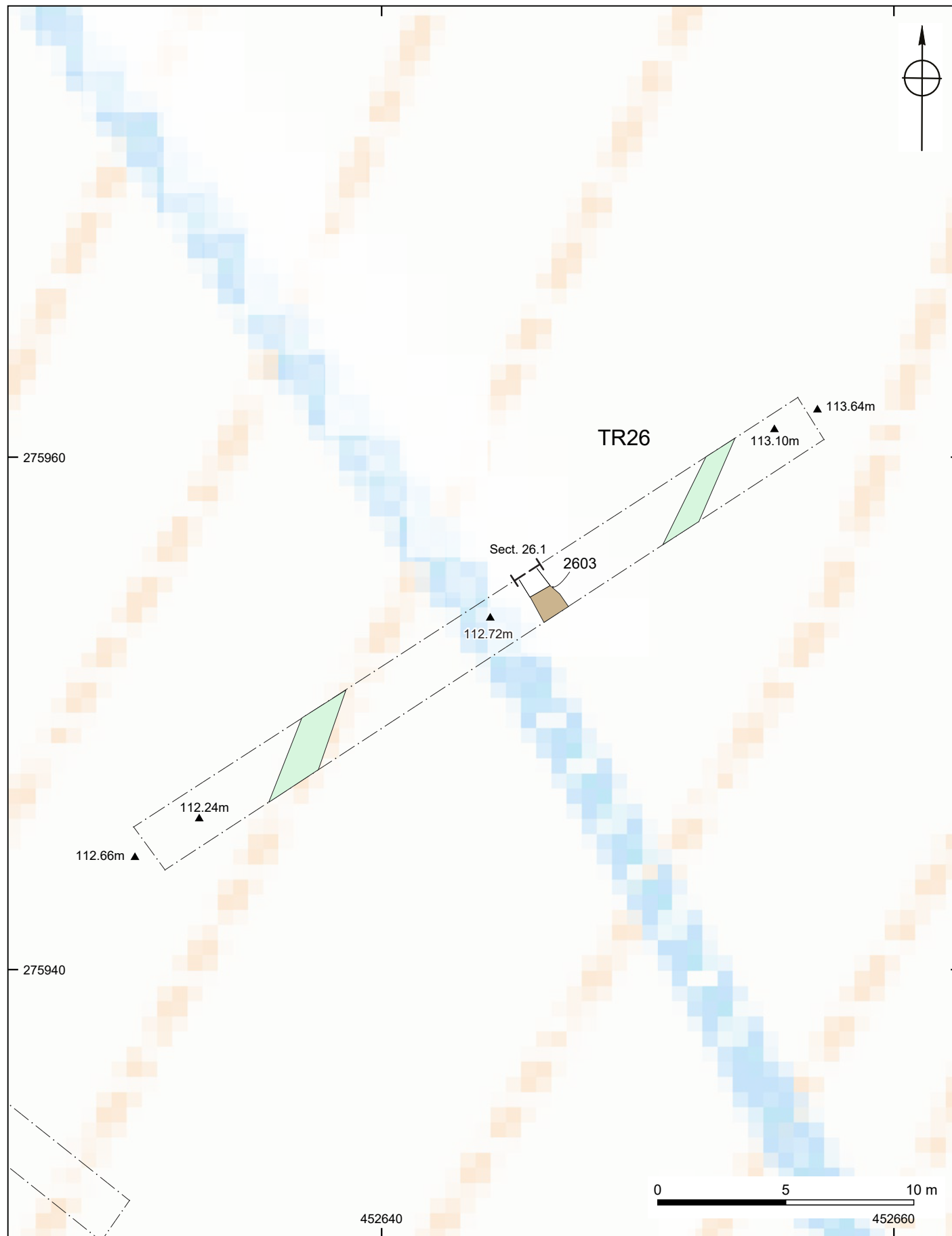

Figure 14.1: Plan of Trench 25



Figure 14.2: Trench 26, facing north-east, 2x1m scales



Figure 14.3: Ditch 2603, facing north-west, 1m scale

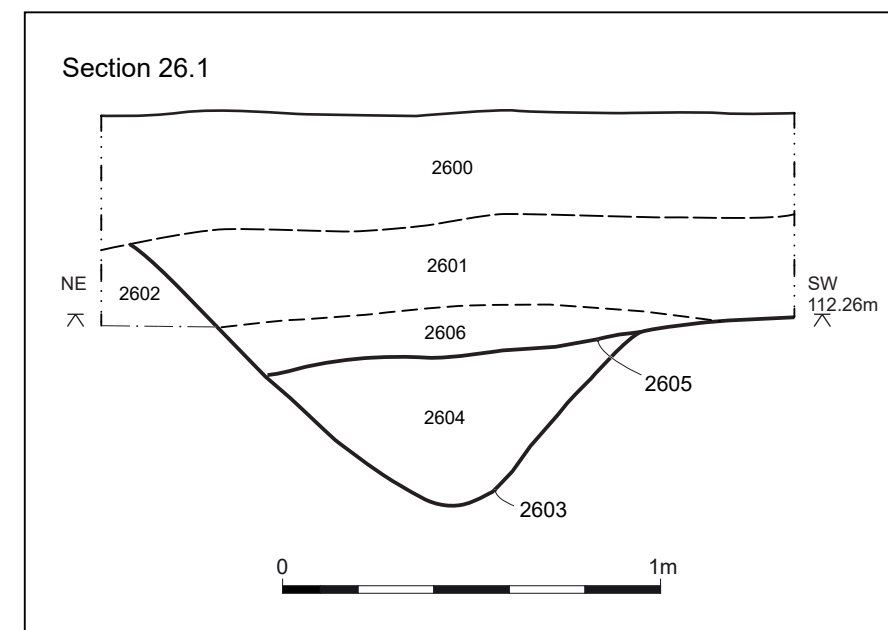

Figure 14.4: Section drawing of ditch 2603

Figure 14

Trench 26

- Edge of trench
- Archaeological feature
- Furrow
- Excavated slot
- Section location
- Spot height

Clifton-upon-Dunsmore,
Warwickshire

WA Project number: P7108

27/02/2026

Created by: Horton, Abbie

File path: U:\U160 ACS\U013
Archaeology Service\03 Field
Section\Projects\Current\P7108
Clifton-upon-Dunsmore,
Warwick\07 Site
Data\Survey\Post fieldwork QGIS

Scale at A3: Plan - 1:200
Section - 1:20



www.explorethepast.co.uk
call: 01905 765908

Part of Worcestershire Archive & Archaeology Service

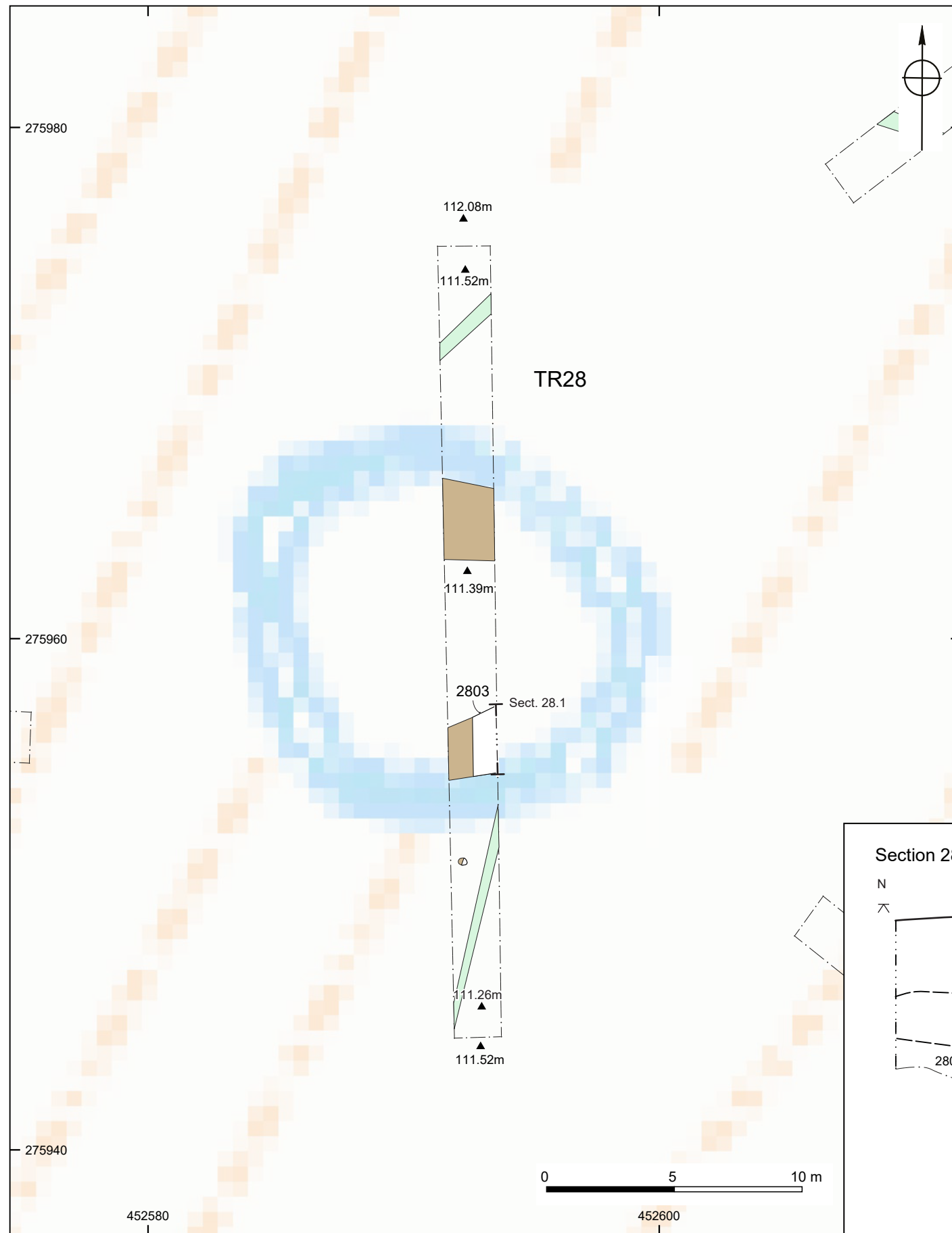

Figure 15.1: Plan of Trench 28



Figure 15.2: Trench 28, facing south, 2x1m scales



Figure 15.3: Features 2803, 2807 and 2810 facing east, 2x1m scales

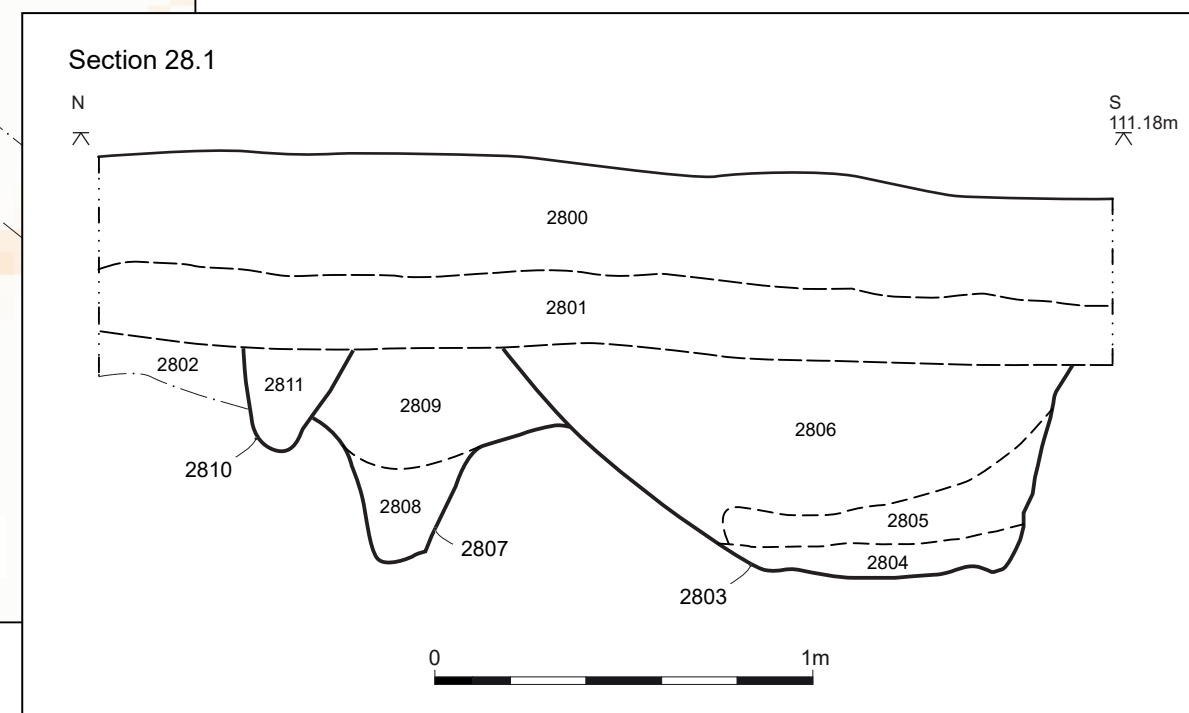

Figure 15.3: Section drawing of features 2803, 2807 and 2810

Figure 15
Trench 28

- Edge of trench
- Archaeological feature
- Furrow
- Excavated slot
- Section location
- Spot height

Clifton-upon-Dunsmore,
Warwickshire

WA Project number: P7108

27/02/2026

Created by: Horton, Abbie

File path: U:\U160 ACS\U013
Archaeology Service\03 Field
Section\Projects\Current\P7108
Clifton-upon-Dunsmore,
Warwick\07 Site
Data\Survey\Post fieldwork QGIS

Scale at A3: Plan - 1:200
Section - 1:20



www.explorethepast.co.uk
call: 01905 765908

Part of Worcestershire Archive & Archaeology Service

Appendix 1: Trench descriptions

Trench 1

Length (m): 30

Width (m): 1.8

Orientation: NE-SW

Context summary:

Context	Feature type	Context type	Height/depth	Deposit description
100	Deposit	Topsoil - Trench 1	0.25 (avg.)	Colour: dark blackish brown. Compaction: wet, friable. Composition: silty clay. Inclusions: frequent medium rounded spheroidal stone, evenly distributed.
101	Deposit	Subsoil - Trench 1	0.15 (avg.)	Colour: mid brown. Compaction: wet, friable. Composition: sandy silt.
102	Deposit	Natural - Trench 1		Colour: mid orangey brown. Compaction: moist, loose. Composition: well sorted sandy cobble. Inclusions: medium sub-rounded spheroidal clay and sand patches, evenly distributed.
103	Cut	Cut - Ditch [103]	> 0.23	Orientation: NE-SW. Shape in plan: regular, linear. Shape in profile: regular, u-shaped. Break at top: sharp. Break at base: gradual. Base: rounded. Sides: moderate, concave.
104	Fill	Fill - Ditch [103]	> 0.23	Colour: brown. Compaction: moist, friable. Composition: medium silty sand.
105	Cut	Cut - Ditch [105]	0.44	Orientation: NW-SE. Shape in plan: regular, curvi-linear. Shape in profile: regular, u-shaped. Break at base: gradual. Base: rounded. Sides: steep, concave.
106	Fill	Fill - Ditch [105]	0.44	Colour: light brown. Compaction: moist, friable. Composition: medium silty sand.

Trench 2

Length (m): 30

Width (m): 1.8

Orientation: NE-SW

Context summary:

Context	Feature type	Context type	Height/depth	Deposit description
200	Deposit	Topsoil - Trench 2	0.30 (avg.)	Colour: dark blackish brown. Compaction: wet, friable. Composition: silty clay. Inclusions: frequent medium rounded spheroidal stone, evenly distributed.
201	Deposit	Subsoil - Trench 2	0.20 (avg.)	Colour: mid brown. Compaction: wet, friable. Composition: sandy silt.
202	Deposit	Natural - Trench 2		Colour: mid orangey brown. Compaction: moist, loose. Composition: well sorted sandy cobble. Inclusions: medium sub-rounded spheroidal clay and sand patches, evenly distributed.
203	Cut	Cut - Ditch [203]	0.44	Orientation: E-W. Shape in plan: linear. Break at top: gradual. Break at base: gradual. Base: rounded. Sides: dipping.
204	Fill	Fill - Ditch [203]	0.15	Colour: mid brownish grey. Compaction: moist, friable. Composition: sandy silt. Inclusions: moderate small to medium sub-rounded to rounded pebble, evenly distributed.
205	Fill	Fill - Ditch [203]	0.35	Colour: mid greyish brown. Compaction: moist, friable. Composition: clayey silt. Inclusions: occasional small to very large sub-rounded to rounded pebble.
206	Fill	Fill - Tree throw [207]	0.73	Colour: dark reddish brown. Compaction: friable. Composition: silty sand.
207	Cut	Cut - Tree throw [207]	0.73	Orientation: N/A. Shape in plan: irregular, oval. Shape in profile: deep v-shaped. Break at top: sharp. Break at base: sharp. Base: uneven. Sides: steep, concave.
208	Fill	Fill - Ditch [209]	0.34	Colour: mid reddish brown. Compaction: friable. Composition: silty sand. Inclusions: frequent pebbles.
209	Cut	Cut - Ditch [209]	0.81	Orientation: NW-SE. Shape in plan: linear. Shape in profile: regular, u-shaped. Break at top: sharp. Break at base: gradual. Base: rounded. Sides: steep, straight.
210	Fill	Fill - Tree throw [211]	0.96	Colour: light yellowish brown. Compaction: friable. Composition: silty sand.
211	Cut	Cut - Tree throw [211]	0.96	Shape in plan: irregular, linear. Shape in profile: irregular, deep. Break at top: sharp.
214	Fill	Fill - Ditch [209]	0.46	Colour: light reddish brown. Compaction: friable. Composition: silty sand. Inclusions: frequent pebbles.

Trench 3

Length (m): 30

Width (m): 1.8

Orientation: N-S

Context summary:

Context	Feature type	Context type	Height/depth	Deposit description
300	Deposit	Topsoil - Trench 3	0.50 (avg.)	Colour: dark blackish brown. Compaction: wet, friable. Composition: silty clay. Inclusions: frequent medium rounded spheroidal stone, evenly distributed.
301	Deposit	Subsoil - Trench 3	0.20 (avg.)	Colour: mid brown. Compaction: wet, friable. Composition: sandy silt.
302	Deposit	Natural - Trench 3		Colour: mid orangey brown. Compaction: moist, loose. Composition: well sorted sandy cobble. Inclusions: medium sub-rounded spheroidal clay and sand patches, evenly distributed.
303	Cut	Cut - Furrow [303]	0.12	Orientation: E-W. Shape in plan: linear. Shape in profile: shallow. Break at top: gradual. Break at base: gradual. Base: flat. Sides: gentle, concave.
304	Fill	Fill - Furrow [303]	0.12	Colour: mid brown. Compaction: wet, friable. Composition: sandy silt.
305	Cut	Cut - Furrow [305]	0.12	Shape in plan: regular, linear. Shape in profile: regular, shallow. Break at top: gradual. Sides: gentle, concave.
306	Fill	Fill - Furrow [305]	0.12	Colour: mid brown. Compaction: wet, friable. Composition: sandy silt.
307	Cut	Cut - Furrow [307]	> 0.10	Orientation: N-S. Shape in plan: linear. Shape in profile: regular, shallow. Break at top: gradual. Sides: gentle, concave.
308	Fill	Fill - Furrow [307]	> 0.10	Colour: mid brown. Compaction: wet, friable. Composition: sandy silt.

Trench 4

Length (m): 30

Width (m): 1.8

Orientation: NW-SE

Context summary:

Context	Feature type	Context type	Height/depth	Deposit description
400	Deposit	Topsoil - Trench 4	0.40 (avg.)	Colour: dark blackish brown. Compaction: wet, friable. Composition: silty clay. Inclusions: frequent medium rounded spheroidal stone, evenly distributed.
401	Deposit	Subsoil - Trench 4	0.40 (avg.)	Colour: light brown. Compaction: moist, friable. Composition: silty clay.
402	Deposit	Natural - Trench 4		Colour: mid orangey brown. Compaction: moist, loose. Composition: well sorted sandy cobble. Inclusions: medium sub-rounded spheroidal clay and sand patches, evenly distributed.
403	Fill	Fill - Pit [404]	0.03	Colour: mid greyish brown. Compaction: friable. Composition: sandy silt.
404	Cut	Cut - Pit [404]	0.03	Orientation: N/A. Shape in plan: irregular, circular. Shape in profile: shallow. Break at top: gradual. Break at base: imperceptible. Base: flat. Sides: moderate, concave.
405	Fill	Fill - Gully [406]	0.23	Colour: mid greyish brown. Compaction: friable. Composition: silty sand.
406	Cut	Cut - Gully [406]	0.23	Orientation: N-S. Shape in plan: irregular spread, terminus. Shape in profile: shallow. Break at top: gradual. Break at base: imperceptible. Base: rounded. Sides: moderate, concave.

Trench 5

Length (m): 30

Width (m): 1.8

Orientation: NE-SW

Context summary:

Context	Feature type	Context type	Height/depth	Deposit description
500	Deposit	Topsoil - Trench 5	0.40 (avg.)	Colour: dark blackish brown. Compaction: wet, friable. Composition: silty clay. Inclusions: frequent medium rounded spheroidal stone, evenly distributed.
501	Deposit	Subsoil - Trench 5	0.30 (avg.)	Colour: mid brown. Compaction: wet, friable. Composition: sandy silt.
502	Deposit	Natural - Trench 5		Colour: mid orangey brown. Compaction: moist, loose. Composition: well sorted sandy cobble. Inclusions: medium sub-rounded spheroidal clay and sand patches, evenly distributed.
503	Cut	Cut - Ditch [503]	0.11	Orientation: NW-SE. Shape in plan: irregular, linear. Shape in profile: irregular, shallow. Break at top: imperceptible. Break at base: imperceptible. Base: rounded. Sides: gentle, concave.
504	Fill	Fill - Ditch [503]	0.11	Colour: mid brownish grey. Compaction: wet, friable. Composition: sandy silt.
505	Cut	Cut - Ditch [505]	0.23	Orientation: NE-SW. Shape in plan: irregular, semi-linear. Shape in profile: regular, shallow. Break at top: gradual. Break at base: imperceptible. Base: flat. Sides: gentle, concave.
506	Fill	Fill - Ditch [505]	0.23	Colour: mid brownish grey. Compaction: moist, friable. Composition: sandy silt.

Trench 6

Length (m): 30

Width (m): 1.8

Orientation: E-W

Context summary:

Context	Feature type	Context type	Height/depth	Deposit description
600	Deposit	Topsoil - Trench 6	0.40 (avg.)	Colour: dark blackish brown. Compaction: wet, friable. Composition: silty clay. Inclusions: frequent medium rounded spheroidal stone, evenly distributed.
601	Deposit	Subsoil - Trench 6	0.50 (avg.)	Colour: mid brown. Compaction: wet, friable. Composition: sandy silt.
602	Deposit	Natural - Trench 6		Colour: mid orangey brown. Compaction: moist, loose. Composition: well sorted sandy cobble. Inclusions: medium sub-rounded spheroidal clay and sand patches, evenly distributed.
603	Cut	Cut - Ditch [603]	0.34	Orientation: E-W. Shape in plan: irregular, curvi-linear. Shape in profile: shallow. Break at top: gradual. Break at base: gradual. Base: flat. Sides: moderate, convex.
604	Fill	Fill - Ditch [603]	0.34	Colour: light orangey grey. Compaction: moist, friable. Composition: sandy silt.
605	Cut	Cut - Ditch [605]	0.4	Orientation: E-W. Shape in plan: regular, linear. Shape in profile: v-shaped. Break at top: sharp. Break at base: gradual. Base: tapered. Sides: steep, straight.
606	Fill	Fill - Ditch [605]	0.4	Colour: mid brownish grey. Compaction: moist, friable. Composition: sandy silt.

Trench 7

Length (m): 30

Width (m): 1.8

Orientation: E-W

Context summary:

Context	Feature type	Context type	Height/depth	Deposit description
700	Deposit	Topsoil - Trench 7	0.40 (avg.)	Colour: dark blackish brown. Compaction: wet, friable. Composition: silty clay. Inclusions: frequent medium rounded spheroidal stone, evenly distributed.
701	Deposit	Subsoil - Trench 7	0.40 (avg.)	Colour: mid brown. Compaction: wet, friable. Composition: sandy silt.
702	Deposit	Natural - Trench 7		Colour: mid orangey brown. Compaction: moist, loose. Composition: well sorted sandy cobble. Inclusions: medium sub-rounded spheroidal clay and sand patches, evenly distributed.
7003	Cut	Cut - Gully [7003]	0.24	Orientation: NE-SW. Shape in plan: regular, curvi-linear. Shape in profile: regular, shallow u-shaped. Break at top: sharp. Break at base: gradual. Base: rounded. Sides: moderate, concave.
7004	Fill	Fill - Gully [7003]	0.24	Colour: brown. Compaction: moist, friable. Composition: medium silty sand.

Trench 8

Length (m): 30

Width (m): 1.8

Orientation: NE-SW

Context summary:

Context	Feature type	Context type	Height/depth	Deposit description
800	Deposit	Topsoil - Trench 8	0.50 (avg.)	Colour: dark blackish brown. Compaction: wet, friable. Composition: silty clay. Inclusions: frequent medium rounded spheroidal stone, evenly distributed.
801	Deposit	Subsoil - Trench 8	0.30 (avg.)	Colour: mid brown. Compaction: wet, friable. Composition: sandy silt.
802	Deposit	Natural - Trench 8		Colour: mid orangey brown. Compaction: moist, loose. Composition: well sorted sandy cobble. Inclusions: medium sub-rounded spheroidal clay and sand patches, evenly distributed.

Trench 9

Length (m): 30

Width (m): 1.8

Orientation: N-S

Context summary:

Context	Feature type	Context type	Height/depth	Deposit description
900	Deposit	Topsoil - Trench 9	0.50 (avg.)	Colour: dark blackish brown. Compaction: wet, friable. Composition: silty clay. Inclusions: frequent medium rounded spheroidal stone, evenly distributed.
901	Deposit	Subsoil - Trench 9	0.40 (avg.)	Colour: mid brown. Compaction: wet, friable. Composition: sandy silt.
902	Deposit	Natural - Trench 9		Colour: mid orangey brown. Compaction: moist, loose. Composition: well sorted sandy cobble. Inclusions: medium sub-rounded spheroidal clay and sand patches, evenly distributed.
903	Fill	Fill - Ditch [904]	0.26	Colour: mid reddish brown. Compaction: friable. Composition: silty sand.
904	Cut	Cut - Ditch [904]	0.26	Orientation: NW-SE. Shape in plan: linear. Shape in profile: shallow. Break at top: sharp. Break at base: imperceptible. Base: flat. Sides: moderate, straight.

Trench 10

Length (m): 30

Width (m): 1.8

Orientation: NE-SW

Context summary:

Context	Feature type	Context type	Height/depth	Deposit description
1000	Deposit	Topsoil - Trench 10	0.20 (avg.)	Colour: dark blackish brown. Compaction: wet, friable. Composition: silty clay. Inclusions: frequent medium rounded spheroidal stone, evenly distributed.
1001	Deposit	Subsoil - Trench 10	0.20 (avg.)	Colour: mid brown. Compaction: wet, friable. Composition: sandy silt.
1002	Deposit	Natural - Trench 10		Colour: mid orangey brown. Compaction: moist, loose. Composition: well sorted sandy cobble. Inclusions: medium sub-rounded spheroidal clay and sand patches, evenly distributed.
1003	Cut	Cut - Pit [1003]	0.06	Orientation: NW-SE. Shape in plan: sub-oval. Shape in profile: regular. Break at top: sharp. Break at base: sharp. Base: flat. Sides: moderate, concave.
1004	Fill	Fill - Pit [1003]	0.06	Colour: dark greyish black. Compaction: moist, friable. Composition: silt. Inclusions: frequent flecks of charcoal.
1005	Cut	Cut - Ditch [1005]	0.48	Orientation: NW-SE. Shape in plan: regular, linear. Shape in profile: regular, deep u-shaped. Break at top: sharp. Break at base: gradual. Base: rounded. Sides: steep, concave.
1006	Fill	Fill - Ditch [1005]	0.2	Colour: brown. Compaction: moist, friable. Composition: medium silty sand. Inclusions: moderate medium to large rounded to well-rounded spheroidal stones, evenly distributed.
1007	Fill	Fill - Ditch [1005]	0.24	Colour: dark whitish brown. Compaction: moist, friable. Composition: medium silty sand.
1008	Fill	Fill - Ditch [1005]	0.22	Colour: greyish brown. Compaction: moist, friable. Composition: medium silty sand.
1009	Cut	Cut - Cremation [1009]	0	Shape in plan: circular. Shape in profile: regular.
1010	Fill	Fill - Cremation [1009]	0	Colour: greyish brown. Compaction: moist, friable. Composition: medium silty sand.

Trench 11

Length (m): 30

Width (m): 1.8

Orientation: N-S

Context summary:

Context	Feature type	Context type	Height/depth	Deposit description
1100	Deposit	Topsoil - Trench 11	0.20 (avg.)	Colour: dark blackish brown. Compaction: wet, friable. Composition: silty clay. Inclusions: frequent medium rounded spheroidal stone, evenly distributed.
1101	Deposit	Subsoil - Trench 11	0.15 (avg.)	Colour: light brown. Compaction: moist, friable. Composition: silty clay.
1102	Deposit	Natural - Trench 11		Colour: mid orangey brown. Compaction: moist, loose. Composition: well sorted sandy cobble. Inclusions: medium sub-rounded spheroidal clay and sand patches, evenly distributed.

Trench 12

Length (m): 30

Width (m): 1.8

Orientation: E-W

Context summary:

Context	Feature type	Context type	Height/depth	Deposit description
1200	Deposit	Topsoil - Trench 12	0.30 (avg.)	Colour: dark blackish brown. Compaction: wet, friable. Composition: silty clay. Inclusions: frequent medium rounded spheroidal stone, evenly distributed.
1201	Deposit	Subsoil - Trench 12	0.20 (avg.)	Colour: mid brown. Compaction: wet, friable. Composition: sandy silt.
1202	Deposit	Natural - Trench 12		Colour: mid orangey brown. Compaction: moist, loose. Composition: well sorted sandy cobble. Inclusions: medium sub-rounded spheroidal clay and sand patches, evenly distributed.

Trench 13

Length (m): 30

Width (m): 1.8

Orientation: N-S

Context summary:

Context	Feature type	Context type	Height/depth	Deposit description
1300	Deposit	Topsoil - Trench 13	0.30 (avg.)	Colour: dark blackish brown. Compaction: wet, friable. Composition: silty clay. Inclusions: frequent medium rounded spheroidal stone, evenly distributed.
1301	Deposit	Subsoil - Trench 13	0.15 (avg.)	Colour: mid brown. Compaction: wet, friable. Composition: sandy silt.
1302	Deposit	Natural - Trench 13		Colour: mid orangey brown. Compaction: moist, loose. Composition: well sorted sandy cobble. Inclusions: medium sub-rounded spheroidal clay and sand patches, evenly distributed.

Trench 14

Length (m): 30

Width (m): 1.8

Orientation: E-W

Context summary:

Context	Feature type	Context type	Height/depth	Deposit description
1400	Deposit	Topsoil - Trench 14	0.30 (avg.)	Colour: dark blackish brown. Compaction: wet, friable. Composition: silty clay. Inclusions: frequent medium rounded spheroidal stone, evenly distributed.
1401	Deposit	Subsoil - Trench 14	0.20 (avg.)	Colour: mid brown. Compaction: wet, friable. Composition: sandy silt.
1402	Deposit	Natural - Trench 14		Colour: mid orangey brown. Compaction: moist, loose. Composition: well sorted sandy cobble. Inclusions: medium sub-rounded spheroidal clay and sand patches, evenly distributed.
1403	Cut	Cut - Gully [1403]	0.18	Orientation: N-S. Shape in plan: regular, linear. Shape in profile: regular, shallow u-shaped. Break at top: sharp. Break at base: gradual. Base: rounded. Sides: moderate, concave.
1404	Fill	Fill - Gully [1403]	0.18	Colour: light brown. Compaction: moist, friable. Composition: medium silty sand.
1405	Cut	Cut - Ditch [1405]	0.33	Shape in plan: regular, linear. Shape in profile: regular, deep u-shaped. Break at top: sharp. Break at base: gradual. Base: rounded. Sides: moderate, concave.
1406	Fill	Fill - Ditch [1405]	0.33	Colour: mid brown. Compaction: moist, friable. Composition: medium silty sand.
1407	Cut	Cut - Natural feature [1407]	0.55	Shape in plan: irregular, sub-rectangular. Shape in profile: deep u-shaped. Break at top: imperceptible. Break at base: gradual. Base: rounded. Sides: moderate, concave.
1408	Fill	Fill - Natural feature [1407]	0.55	Colour: light brown. Compaction: moist, friable. Composition: silty sand.

Trench 15

Length (m): 30

Width (m): 1.8

Orientation: N-S

Context summary:

Context	Feature type	Context type	Height/depth	Deposit description
1500	Deposit	Topsoil - Trench 15	0.30 (avg.)	Colour: dark brown. Compaction: moist, friable. Composition: silty clay.
1501	Deposit	Subsoil - Trench 15	0.25 (avg.)	Colour: light brown. Compaction: moist, friable. Composition: silty clay.
1502	Deposit	Natural - Trench 15		Colour: yellowish brown. Compaction: moist, friable. Composition: silty clay.

Trench 16

Length (m): 30

Width (m): 1.8

Orientation: E-W

Context summary:

Context	Feature type	Context type	Height/depth	Deposit description
1600	Deposit	Topsoil - Trench 16	0.20 (avg.)	Colour: dark blackish brown. Compaction: wet, friable. Composition: silty clay. Inclusions: frequent medium rounded spheroidal stone, evenly distributed.
1601	Deposit	Subsoil - Trench 16	0.25 (avg.)	Colour: mid brown. Compaction: wet, friable. Composition: sandy silt.
1602	Deposit	Natural - Trench 16		Colour: mid orangey brown. Compaction: moist, loose. Composition: well sorted sandy cobble. Inclusions: medium sub-rounded spheroidal clay and sand patches, evenly distributed.

Trench 17

Length (m): 30

Width (m): 1.8

Orientation: NW-SE

Context summary:

Context	Feature type	Context type	Height/depth	Deposit description
1700	Deposit	Topsoil - Trench 17	0.20 (avg.)	Colour: dark blackish brown. Compaction: wet, friable. Composition: silty clay. Inclusions: frequent medium rounded spheroidal stone, evenly distributed.
1701	Deposit	Subsoil - Trench 17	0.25 (avg.)	Colour: mid brown. Compaction: wet, friable. Composition: sandy silt.
1702	Deposit	Natural - Trench 17		Colour: mid orangey brown. Compaction: moist, loose. Composition: well sorted sandy cobble. Inclusions: medium sub-rounded spheroidal clay and sand patches, evenly distributed.

Trench 18

Length (m): 30

Width (m): 1.8

Orientation: E-W

Context summary:

Context	Feature type	Context type	Height/depth	Deposit description
1800	Deposit	Topsoil - Trench 18	0.25 (avg.)	Colour: dark blackish brown. Compaction: wet, friable. Composition: silty clay. Inclusions: frequent medium rounded spheroidal stone, evenly distributed.
1801	Deposit	Subsoil - Trench 18	0.25 (avg.)	Colour: mid brown. Compaction: wet, friable. Composition: sandy silt.
1802	Deposit	Natural - Trench 18		Colour: mid orangey brown. Compaction: moist, loose. Composition: well sorted sandy cobble. Inclusions: medium sub-rounded spheroidal clay and sand patches, evenly distributed.
1803	Fill	Fill - Ditch [1804]	0.28	Colour: mid orangey brown. Compaction: friable. Composition: silty sand.
1804	Cut	Cut - Ditch [1804]	0.28	Orientation: NE-SW. Shape in plan: linear. Shape in profile: shallow u-shaped. Break at top: sharp. Break at base: gradual. Base: flat. Sides: moderate, straight.

Trench 19

Length (m): 30

Width (m): 1.8

Orientation: NE-SW

Context summary:

Context	Feature type	Context type	Height/depth	Deposit description
1900	Deposit	Topsoil - Trench 19	0.25 (avg.)	Colour: dark blackish brown. Compaction: wet, friable. Composition: silty clay. Inclusions: frequent medium rounded spheroidal stone, evenly distributed.
1901	Deposit	Subsoil - Trench 19	0.25 (avg.)	Colour: mid brown. Compaction: wet, friable. Composition: sandy silt.
1902	Deposit	Natural - Trench 19		Colour: mid orangey brown. Compaction: moist, loose. Composition: well sorted sandy cobble. Inclusions: medium sub-rounded spheroidal clay and sand patches, evenly distributed.
1903	Cut	Cut - Furrow [1903]	0.27	Orientation: E-W. Shape in plan: regular, linear. Shape in profile: regular, shallow. Break at top: gradual. Break at base: sharp. Base: flat. Sides: steep, straight.
1904	Fill	Fill - Furrow [1903]	0.27	Colour: mid brownish orange. Compaction: wet, malleable. Composition: silty clay. Inclusions: occasional small to large rounded to well-rounded spheroidal stones, evenly distributed.
1905	Cut	Cut - Linear [1905]	0.24	Shape in plan: regular, linear. Shape in profile: irregular, shallow. Break at top: sharp. Break at base: sharp. Base: flat. Sides: moderate, convex.
1906	Fill	Fill - Linear [1905]	0.24	Colour: mid yellowish orange. Compaction: wet, malleable. Composition: clayey silt. Inclusions: small to large rounded to well-rounded spheroidal stone, evenly distributed.

Trench 20

Length (m): 30

Width (m): 1.8

Orientation: N-S

Context summary:

Context	Feature type	Context type	Height/depth	Deposit description
2000	Deposit	Topsoil - Trench 20	0.20 (avg.)	Colour: dark blackish brown. Compaction: wet, friable. Composition: silty clay. Inclusions: frequent medium rounded spheroidal stone, evenly distributed.
2001	Deposit	Subsoil - Trench 20	0.30 (avg.)	Colour: mid brown. Compaction: wet, friable. Composition: sandy silt.
2002	Deposit	Natural - Trench 20		Colour: mid orangey brown. Compaction: moist, loose. Composition: well sorted sandy cobble. Inclusions: medium sub-rounded spheroidal clay and sand patches, evenly distributed.
2004	Cut	Cut - Furrow [2004]	0.22	Orientation: E-W. Shape in plan: regular, linear. Shape in profile: regular, shallow u-shaped. Break at top: gradual. Break at base: gradual. Base: rounded. Sides: moderate, concave.
2005	Fill	Fill - Furrow [2004]	0.22	Colour: brown. Compaction: moist, loose. Composition: medium silty sand.
2006	Cut	Cut - Ditch [2006]	0.31	Orientation: E-W. Shape in plan: regular, linear. Shape in profile: regular, shallow v-shaped. Break at top: sharp. Break at base: gradual. Base: tapered. Sides: moderate, concave.
2007	Fill	Fill - Ditch [2006]	0.31	Colour: brown. Compaction: moist, loose. Composition: medium silty sand.
2008	Cut	Cut - Pit [2008]	0.15	Orientation: N-S. Shape in plan: regular, sub-oval. Shape in profile: regular, shallow u-shaped. Break at top: sharp. Break at base: gradual. Base: rounded. Sides: steep, concave.
2009	Fill	Fill - Pit [2008]	0.15	Colour: yellowish brown. Compaction: moist, loose. Composition: medium silty sand.
2010	Cut	Cut - Furrow [2010]	0.3	Orientation: E-W. Shape in plan: linear. Shape in profile: shallow u-shaped. Break at top: sharp. Break at base: gradual. Base: rounded. Sides: moderate, concave.
2011	Fill	Fill - Furrow [2010]	0.3	Colour: brown. Compaction: moist, loose. Composition: medium silty sand.
2012	Cut	Cut - Pit [2012]	0.33	Orientation: N-S. Shape in plan: regular, sub-oval. Shape in profile: regular, shallow u-shaped. Break at top: sharp. Break at base: gradual. Base: rounded. Sides: moderate, concave.
2013	Fill	Fill - Pit [2012]	0.33	Colour: mid yellowish brown. Compaction: moist, loose. Composition: medium silty sand.

Trench 21

Length (m): 30

Width (m): 1.8

Orientation: NW-SE

Context summary:

Context	Feature type	Context type	Height/depth	Deposit description
2100	Deposit	Topsoil - Trench 21	0.30 (avg.)	Colour: dark brown. Compaction: moist, friable. Composition: silty clay.
2101	Deposit	Subsoil - Trench 21	0.20 (avg.)	Colour: light brown. Compaction: moist, friable. Composition: silty clay.
2102	Deposit	Natural - Trench 21		Colour: mid orangey brown. Compaction: waterlogged, loose. Composition: well sorted sandy cobble. Inclusions: medium sub-rounded spheroidal clay and sand patches, evenly distributed.
2103	Cut	Cut - Gully [2103]	0.32	Orientation: NE-SW. Shape in plan: regular, curvi-linear. Shape in profile: regular, shallow u-shaped. Break at top: sharp. Break at base: gradual. Base: rounded. Sides: moderate, concave.
2104	Fill	Fill - Gully [2103]	0.32	Colour: greyish brown. Compaction: moist, friable. Composition: medium silty sand.
2105	Cut	Cut - Gully [2105]	0.25	Orientation: NE-SW. Shape in plan: regular, curvi-linear. Shape in profile: regular, shallow u-shaped. Break at top: sharp. Break at base: gradual. Base: rounded. Sides: moderate, concave.
2106	Fill	Fill - Gully [2105]	0.25	Colour: yellowish brown. Compaction: moist, friable. Composition: medium silty sand.

Trench 22

Length (m): 30

Width (m): 1.8

Orientation: NE-SW

Context summary:

Context	Feature type	Context type	Height/depth	Deposit description
2200	Deposit	Topsoil - Trench 22	0.33 (avg.)	Colour: dark brown. Compaction: moist, friable. Composition: silty clay.
2201	Deposit	Subsoil - Trench 22	0.24 (avg.)	Colour: light brown. Compaction: moist, friable. Composition: silty clay.
2202	Deposit	Natural - Trench 22		Colour: mid yellowish brown. Compaction: moist, loose. Composition: medium silty sand.
2203	Cut	Cut - Pit [2203]	0.13	Orientation: E-W. Shape in plan: regular, sub-oval. Shape in profile: regular, shallow u-shaped. Break at top: gradual. Break at base: gradual. Base: rounded. Sides: moderate, concave.
2204	Fill	Fill - Pit [2203]	0.13	Colour: brown. Compaction: moist, loose. Composition: medium silty sand. Inclusions: occasional medium to large rounded spheroidal stones.
2205	Cut	Cut - Ditch [2205]	0.22	Orientation: NE-SW. Shape in plan: regular, linear. Shape in profile: regular, shallow u-shaped. Break at top: sharp. Break at base: gradual. Base: rounded. Sides: moderate, concave.
2206	Fill	Fill - Ditch [2205]	0.22	Colour: brown. Compaction: moist, friable. Composition: medium silty sand.
2207	Cut	Cut - Furrow [2207]	0.26	Orientation: N-S. Shape in plan: regular, linear. Shape in profile: regular, shallow. Break at top: sharp. Break at base: gradual. Base: flat. Sides: moderate, concave.
2208	Fill	Fill - Furrow [2207]	0.26	Colour: brown. Compaction: moist, friable. Composition: medium silty sand.
2209	Cut	Cut - Ditch [2209]	0.26	Orientation: NE-SW. Shape in plan: regular, linear. Shape in profile: regular, shallow. Break at top: sharp. Break at base: gradual. Base: rounded. Sides: gentle, concave.
2210	Fill	Fill - Ditch [2209]	0.26	Colour: brown. Compaction: moist, friable. Composition: medium silty sand.
2211	Cut	Cut - Furrow [2211]	0.35	Orientation: NW-SE. Shape in plan: irregular, linear. Shape in profile: regular, shallow u-shaped. Break at top: sharp. Break at base: gradual. Base: rounded. Sides: gentle, concave.
2212	Fill	Fill - Furrow [2211]	0.35	Colour: brown. Compaction: moist, friable. Composition: medium silty sand.

Trench 23

Length (m): 30

Width (m): 1.8

Orientation: N-S

Context summary:

Context	Feature type	Context type	Height/depth	Deposit description
2300	Deposit	Topsoil - Trench 23	0.25 (avg.)	Colour: dark blackish brown. Compaction: wet, friable. Composition: silty clay. Inclusions: frequent medium rounded spheroidal stone, evenly distributed.
2301	Deposit	Subsoil - Trench 23	0.25 (avg.)	Colour: mid brown. Compaction: wet, friable. Composition: sandy silt.
2302	Deposit	Natural - Trench 23		Colour: mid orangey brown. Compaction: moist, loose. Composition: well sorted sandy cobble. Inclusions: medium sub-rounded spheroidal clay and sand patches, evenly distributed.
2303	Cut	Cut - Ditch [2303]	0.37	Orientation: N-S. Shape in plan: irregular, sub-linear. Shape in profile: irregular, shallow. Break at top: gradual. Break at base: gradual. Base: rounded. Sides: gentle, convex.
2304	Fill	Fill - Ditch [2303]	0.32	Colour: light orangey yellow. Compaction: moist, friable. Composition: silt.
2305	Fill	Fill - Ditch [2303]	0.37	Colour: mid orangey brown. Compaction: moist, malleable. Composition: clayey silt.
2306	Cut	Cut - Ditch [2306]	0.2	Orientation: NW-SE. Shape in plan: irregular, linear. Shape in profile: irregular, shallow. Break at top: gradual. Break at base: imperceptible. Base: rounded. Sides: gentle, concave.
2307	Fill	Fill - Ditch [2306]	0.2	Colour: mid orangey brown. Compaction: moist, malleable. Composition: silty clay.

Trench 24

Length (m): 30

Width (m): 1.8

Orientation: N-S

Context summary:

Context	Feature type	Context type	Height/depth	Deposit description
2400	Deposit	Topsoil - Trench 24	0.30 (avg.)	
2401	Deposit	Subsoil - Trench 24	0.20 (avg.)	Colour: mid brown. Compaction: wet, friable. Composition: sandy silt.
2402	Deposit	Natural - Trench 24		Colour: mid orangey brown. Compaction: moist, loose. Composition: well sorted sandy cobble. Inclusions: medium sub-rounded spheroidal clay and sand patches, evenly distributed.

Trench 25

Length (m): 30

Width (m): 1.8

Orientation: NE-SW

Context summary:

Context	Feature type	Context type	Height/depth	Deposit description
2500	Deposit	Topsoil - Trench 25	0.30 (avg.)	Colour: dark brown. Compaction: moist, friable. Composition: silty clay.
2501	Deposit	Subsoil - Trench 25	0.20 (avg.)	Colour: mid brown. Compaction: wet, friable. Composition: sandy silt.
2502	Deposit	Natural - Trench 25		Colour: mid orangey brown. Compaction: moist, loose. Composition: well sorted sandy cobble. Inclusions: medium sub-rounded spheroidal clay and sand patches, evenly distributed.
2503	Fill	Fill - Pit [2505]	0.28	Colour: mid reddish brown. Compaction: friable. Composition: silty sand.
2504	Fill	Fill - Pit [2505]	0.17	Colour: dark greyish brown. Compaction: friable. Composition: silty sand. Inclusions: rare charcoal.
2505	Cut	Cut - Pit [2505]	0.4	Orientation: N/A. Shape in plan: regular, oval. Shape in profile: deep u-shaped. Break at top: sharp. Break at base: gradual. Base: rounded. Sides: moderate, concave.
2506	Fill	Fill - Pit [2505]	0.08	Colour: light yellowish brown. Compaction: loose. Composition: sand.

Trench 26

Length (m): 30

Width (m): 1.8

Orientation: NE-SW

Context summary:

Context	Feature type	Context type	Height/depth	Deposit description
2600	Deposit	Topsoil - Trench 26	0.30 (avg.)	Colour: dark brown. Compaction: moist, friable. Composition: silty clay.
2601	Deposit	Subsoil - Trench 26	0.20 (avg.)	Colour: mid brown. Compaction: wet, friable. Composition: sandy silt.
2602	Deposit	Natural - Trench 26		Colour: mid orangey brown. Compaction: moist, loose. Composition: well sorted sandy cobble. Inclusions: medium sub-rounded spheroidal clay and sand patches, evenly distributed.
2603	Cut	Cut - Ditch [2603]	0.4	Orientation: NW-SE. Shape in plan: regular, linear. Shape in profile: regular, deep u-shaped. Break at top: sharp. Break at base: gradual. Base: rounded. Sides: moderate, concave.
2604	Fill	Fill - Ditch [2603]	0.4	Colour: mid brown. Compaction: moist, friable. Composition: medium silty sand. Inclusions: frequent medium to large rounded spheroidal stones, evenly distributed.
2605	Cut	Cut - Furrow [2605]	0.15	Orientation: NE-SW. Shape in plan: irregular, linear. Shape in profile: irregular, shallow. Break at top: none. Break at base: imperceptible. Base: flat.
2606	Fill	Fill - Furrow [2605]	0.15	Colour: greyish brown. Compaction: moist, friable. Composition: silty sand.

Trench 27

Length (m): 30

Width (m): 1.8

Orientation: E-W

Context summary:

Context	Feature type	Context type	Height/depth	Deposit description
2700	Deposit	Topsoil - Trench 27	0.30 (avg.)	Colour: dark blackish brown. Compaction: wet, friable. Composition: silty clay. Inclusions: frequent medium rounded spheroidal stone, evenly distributed.
2701	Deposit	Subsoil - Trench 27	0.20 (avg.)	Colour: mid brown. Compaction: wet, friable. Composition: sandy silt.
2702	Deposit	Natural - Trench 27		Colour: mid orangey brown. Compaction: moist, loose. Composition: well sorted sandy cobble. Inclusions: medium sub-rounded spheroidal clay and sand patches, evenly distributed.

Trench 28

Length (m): 30

Width (m): 1.8

Orientation: N-S

Context summary:

Context	Feature type	Context type	Height/depth	Deposit description
2800	Deposit	Topsoil - Trench 28	0.20 (avg.)	Colour: dark blackish brown. Compaction: wet, friable. Composition: silty clay. Inclusions: frequent medium rounded spheroidal stone, evenly distributed.
2801	Deposit	Subsoil - Trench 28	0.10 (avg.)	Colour: mid brown. Compaction: wet, friable. Composition: sandy silt.
2802	Deposit	Natural - Trench 28		Colour: mid orangey brown. Compaction: moist, loose. Composition: well sorted sandy cobble. Inclusions: medium sub-rounded spheroidal clay and sand patches, evenly distributed.
2803	Cut	Cut - Ditch [2803]	0.7	Orientation: NW-SE. Shape in plan: regular, curvi-linear. Shape in profile: regular, deep u-shaped. Break at top: sharp. Break at base: sharp. Base: flat. Sides: steep, concave.
2804	Fill	Fill - Ditch [2803]	0.08	Colour: greyish brown. Compaction: moist, friable. Composition: medium silty sand.
2805	Fill	Fill - Ditch [2803]	0.3	Colour: yellowish brown. Compaction: moist, friable. Composition: medium silty sand.
2806	Fill	Fill - Ditch [2803]	0.62	Colour: brown. Compaction: moist, friable. Composition: medium silty sand. Inclusions: frequent small to medium sub-rounded to rounded platy stones, evenly distributed.
2807	Cut	Cut - Gully [2807]	0.6	Orientation: E-W. Shape in plan: regular, linear. Shape in profile: regular, deep v-shaped. Break at top: none. Break at base: sharp. Base: rounded. Sides: steep, concave.
2808	Fill	Fill - Gully [2807]	0.22	Colour: dark yellowish brown. Compaction: moist, friable. Composition: medium silty sand.
2809	Fill	Fill - Gully [2807]	0.34	Colour: brown. Compaction: moist, friable. Composition: medium silty sand.
2810	Cut	Cut - Posthole [2810]	0.27	Orientation: N-S. Shape in plan: regular, sub-oval. Shape in profile: regular, deep u-shaped. Break at top: sharp. Break at base: sharp. Base: rounded. Sides: steep, straight.
2811	Fill	Fill - Posthole [2810]	0.27	Colour: brown. Compaction: moist, friable. Composition: medium silty sand.
2812	Cut	Cut - Posthole [2812]	0.07	Orientation: NW-SE. Shape in plan: regular, sub-oval. Shape in profile: regular, shallow u-shaped. Break at top: sharp. Break at base: gradual. Base: rounded. Sides: moderate, concave.
2813	Fill	Fill - Posthole [2812]	0.07	Colour: brownish grey. Compaction: moist, friable. Composition: medium silty sand.
2814	Fill	Fill - Ditch [2815]	0	Colour: brown. Compaction: moist, friable. Composition: silty sand.

2815	Cut	Cut - Ditch [2815]	0	Orientation: E-W. Shape in plan: regular, linear. Shape in profile: regular.
2816	Cut	Cut - Ditch [2816]	0	Orientation: E-W. Shape in plan: linear.
2817	Fill	Fill - Ditch [2816]	0	Colour: brown. Compaction: moist, friable. Composition: medium silty sand.

Trench 29

Length (m): 30 Width (m): 1.8 Orientation: NW-SE

Context summary:

Context	Feature type	Context type	Height/depth	Deposit description
2900	Deposit	Topsoil - Trench 29	0.30 (avg.)	Colour: dark blackish brown. Compaction: wet, friable. Composition: silty clay. Inclusions: frequent medium rounded spheroidal stone, evenly distributed.
2901	Deposit	Subsoil - Trench 29	0.20 (avg.)	Colour: mid brown. Compaction: wet, friable. Composition: sandy silt.
2902	Deposit	Natural - Trench 29		Colour: mid orangey brown. Compaction: moist, loose. Composition: well sorted sandy cobble. Inclusions: medium sub-rounded spheroidal clay and sand patches, evenly distributed.

Trench 30

Length (m): 30 Width (m): 1.8 Orientation: E-W

Context summary:

Context	Feature type	Context type	Height/depth	Deposit description
3000	Deposit	Topsoil - Trench 30	0.25 (avg.)	Colour: dark blackish brown. Compaction: wet, friable. Composition: silty clay. Inclusions: frequent medium rounded spheroidal stone, evenly distributed.
3001	Deposit	Subsoil - Trench 30	0.20 (avg.)	Colour: mid brown. Compaction: wet, friable. Composition: sandy silt.
3002	Deposit	Natural - Trench 30		Colour: mid orangey brown. Compaction: moist, loose. Composition: well sorted sandy cobble. Inclusions: medium sub-rounded spheroidal clay and sand patches, evenly distributed.

Trench 31

Length (m): 30

Width (m): 1.8

Orientation: NE-SW

Context summary:

Context	Feature type	Context type	Height/depth	Deposit description
3100	Deposit	Topsoil - Trench 31	0.25 (avg.)	Colour: dark blackish brown. Compaction: wet, friable. Composition: silty clay. Inclusions: frequent medium rounded spheroidal stone, evenly distributed.
3101	Deposit	Subsoil - Trench 31	0.20 (avg.)	Colour: mid brown. Compaction: wet, friable. Composition: sandy silt.
3102	Deposit	Natural - Trench 31		Colour: mid orangey brown. Compaction: moist, loose. Composition: well sorted sandy cobble. Inclusions: medium sub-rounded spheroidal clay and sand patches, evenly distributed.

Trench 32

Length (m): 30

Width (m): 1.8

Orientation: E-W

Context summary:

Context	Feature type	Context type	Height/depth	Deposit description
3200	Deposit	Topsoil - Trench 32	0.34 (avg.)	Colour: dark brown. Compaction: moist, friable. Composition: silty clay.
3201	Deposit	Subsoil - Trench 32	0.25 (avg.)	Colour: mid greyish brown. Compaction: moist, friable. Composition: silty clay.
3202	Deposit	Natural - Trench 32		Colour: mid orangey brown. Compaction: moist, loose. Composition: well sorted sandy cobble. Inclusions: medium sub-rounded spheroidal clay and sand patches, evenly distributed.
3203	Fill	Fill - Pit [3204]	0.24	Colour: mid orangey brown. Compaction: friable. Composition: silty sand. Inclusions: occasional flecks of charcoal.
3204	Cut	Cut - Pit [3204]	0.24	Orientation: N/A. Shape in plan: oval. Shape in profile: shallow. Break at top: sharp. Break at base: imperceptible. Base: flat. Sides: moderate, concave.

Trench 33

Length (m): 30

Width (m): 1.8

Orientation: N-S

Context summary:

Context	Feature type	Context type	Height/depth	Deposit description
3300	Deposit	Topsoil - Trench 33	0.34 (avg.)	Colour: dark brown. Compaction: moist, friable. Composition: silty clay.
3301	Deposit	Subsoil - Trench 33	0.26 (avg.)	Colour: mid brown. Compaction: moist, friable. Composition: silty clay.
3302	Deposit	Natural - Trench 33	0	Colour: yellow. Compaction: moist, loose. Composition: medium silty sand.
3303	Fill	Fill - Ditch [3304]	0.2	Colour: mid yellowish brown. Compaction: friable. Composition: silty sand.
3304	Cut	Cut - Ditch [3304]	0.2	Orientation: NE-SW. Shape in plan: irregular spread, terminus. Shape in profile: regular, u-shaped. Break at top: sharp. Break at base: gradual. Base: rounded. Sides: steep, straight.

Trench 34

Length (m): 30

Width (m): 1.8

Orientation: NE-SW

Context summary:

Context	Feature type	Context type	Height/depth	Deposit description
3400	Deposit	Topsoil - Trench 34	0.32 (avg.)	Colour: dark brown. Compaction: moist, friable. Composition: silty clay.
3401	Deposit	Subsoil - Trench 34	0.24 (avg.)	Colour: mid greyish brown. Compaction: moist, friable. Composition: silty clay.
3402	Deposit	Natural - Trench 34	0	Colour: yellowish brown. Compaction: moist, loose. Composition: sand.
3403	Fill	Fill - Ditch [3404]		Colour: mid reddish brown. Compaction: friable. Composition: silty sand.
3404	Cut	Cut - Ditch [3404]	0.28	Orientation: NE-SW. Shape in plan: irregular spread, terminus. Shape in profile: regular, u-shaped. Break at top: sharp. Break at base: gradual. Base: rounded. Sides: steep, straight.

Trench 35

Length (m): 30 Width (m): 1.8 Orientation: N-S

Context summary:

Context	Feature type	Context type	Height/depth	Deposit description
3500	Deposit	Topsoil - Trench 35	0.25 (avg.)	Colour: dark brown. Compaction: moist, friable. Composition: silty clay.
3501	Deposit	Subsoil - Trench 35	0.28 (avg.)	Colour: mid greyish brown. Compaction: moist, friable. Composition: silty clay.
3502	Deposit	Natural - Trench 35		Colour: yellowish brown. Compaction: wet, loose. Composition: sand.

Trench 36

Length (m): 30 Width (m): 1.8 Orientation: NW-SE

Context summary:

Context	Feature type	Context type	Height/depth	Deposit description
3600	Deposit	Topsoil - Trench 36	0.32 (avg.)	Colour: dark blackish brown. Compaction: wet, friable. Composition: silty clay. Inclusions: frequent medium rounded spheroidal stone, evenly distributed.
3601	Deposit	Subsoil - Trench 36	0.15 (avg.)	Colour: mid brown. Compaction: wet, friable. Composition: sandy silt.
3602	Deposit	Natural - Trench 36		Colour: mid orangey brown. Compaction: moist, loose. Composition: well sorted sandy cobble. Inclusions: medium sub-rounded spheroidal clay and sand patches, evenly distributed.

Trench 37

Length (m): 30 Width (m): 1.8 Orientation: NW-SE

Context summary:

Context	Feature type	Context type	Height/depth	Deposit description
3700	Deposit	Topsoil - Trench 37	0.38 (avg.)	Colour: dark blackish brown. Compaction: wet, friable. Composition: silty clay. Inclusions: frequent medium rounded spheroidal stone, evenly distributed.
3701	Deposit	Subsoil - Trench 37	0.30 (avg.)	Colour: mid brown. Compaction: wet, friable. Composition: sandy silt.
3702	Deposit	Natural - Trench 37		Colour: mid orangey brown. Compaction: moist, loose. Composition: well sorted sandy cobble. Inclusions: medium sub-rounded spheroidal clay and sand patches, evenly distributed.

Trench 38

Length (m): 30

Width (m): 1.8

Orientation: N-S

Context summary:

Context	Feature type	Context type	Height/depth	Deposit description
3800	Deposit	Topsoil - Trench 38	0.30 (avg.)	Colour: dark blackish brown. Compaction: wet, friable. Composition: silty clay. Inclusions: frequent medium rounded spheroidal stone, evenly distributed.
3801	Deposit	Subsoil - Trench 38	0.20 (avg.)	Colour: mid brown. Compaction: wet, friable. Composition: sandy silt.
3802	Deposit	Natural - Trench 38		Colour: mid orangey brown. Compaction: moist, loose. Composition: well sorted sandy cobble. Inclusions: medium sub-rounded spheroidal clay and sand patches, evenly distributed.

Trench 39

Length (m): 30

Width (m): 1.8

Orientation: E-W

Context summary:

Context	Feature type	Context type	Height/depth	Deposit description
3900	Deposit	Topsoil - Trench 39	0.25 (avg.)	Colour: dark blackish brown. Compaction: wet, friable. Composition: silty clay. Inclusions: frequent medium rounded spheroidal stone, evenly distributed.
3901	Deposit	Subsoil - Trench 39	0.20 (avg.)	Colour: mid brown. Compaction: wet, friable. Composition: sandy silt.
3902	Deposit	Natural - Trench 39		Colour: mid orangey brown. Compaction: moist, loose. Composition: well sorted sandy cobble. Inclusions: medium sub-rounded spheroidal clay and sand patches, evenly distributed.
3903	Cut	Cut - Tree throw [3903]	0.3	Orientation: NE-SW. Shape in plan: irregular, curvi-oval. Shape in profile: shallow. Break at top: gradual. Break at base: imperceptible. Base: flat. Sides: gentle, concave.
3904	Fill	Fill - Tree throw [3903]	0.3	Colour: mid greyish orange. Compaction: wet, malleable. Composition: clayey silt. Inclusions: occasional small to large rounded to well-rounded spheroidal stone, evenly distributed.
3905	Fill	Fill - Tree throw [3903]	0.2	Colour: mid yellowish orange. Compaction: moist, friable. Composition: clayey silt.

Trench 40

Length (m): 30

Width (m): 1.8

Orientation: N-S

Context summary:

Context	Feature type	Context type	Height/depth	Deposit description
4000	Deposit	Topsoil - Trench 40	0.36 (avg.)	Colour: dark blackish brown. Compaction: wet, friable. Composition: silty clay. Inclusions: frequent medium rounded spheroidal stone, evenly distributed.
4001	Deposit	Subsoil - Trench 40	0.14 (avg.)	Colour: mid brown. Compaction: wet, friable. Composition: sandy silt.
4002	Deposit	Natural - Trench 40		Colour: mid orangey brown. Compaction: moist, loose. Composition: well sorted sandy cobble. Inclusions: medium sub-rounded spheroidal clay and sand patches, evenly distributed.

Trench 41

Length (m): 30

Width (m): 1.8

Orientation: N-S

Context summary:

Context	Feature type	Context type	Height/depth	Deposit description
4100	Deposit	Topsoil - Trench 41	0.30 (avg.)	Colour: dark blackish brown. Compaction: wet, friable. Composition: silty clay. Inclusions: frequent medium rounded spheroidal stone, evenly distributed.
4101	Deposit	Subsoil - Trench 41	0.20 (avg.)	Colour: mid brown. Compaction: wet, friable. Composition: sandy silt.
4102	Deposit	Natural - Trench 41		Colour: mid orangey brown. Compaction: moist, loose. Composition: well sorted sandy cobble. Inclusions: medium sub-rounded spheroidal clay and sand patches, evenly distributed.

Trench 42

Length (m): 30

Width (m): 1.8

Orientation: NE-SW

Context summary:

Context	Feature type	Context type	Height/depth	Deposit description
4200	Deposit	Topsoil - Trench 42	0.25 (avg.)	Colour: dark blackish brown. Compaction: wet, friable. Composition: silty clay. Inclusions: frequent medium rounded spheroidal stone, evenly distributed.
4201	Deposit	Subsoil - Trench 42	0.28 (avg.)	Colour: mid brown. Compaction: wet, friable. Composition: sandy silt.
4202	Deposit	Natural - Trench 42		Colour: mid orangey brown. Compaction: moist, loose. Composition: well sorted sandy cobble. Inclusions: medium sub-rounded spheroidal clay and sand patches, evenly distributed.
4203	Cut	Cut - Pit [4203]	0.45	Orientation: NE-SW. Shape in plan: semi-oval. Shape in profile: regular, shallow. Break at top: gradual. Break at base: gradual. Base: rounded. Sides: moderate, concave.
4204	Fill	Fill - Pit [4203]	0.45	Colour: mid orangey brown. Compaction: moist, loose. Composition: coarse silty sand. Inclusions: frequent small to large sub-angular to rounded spheroidal stones, evenly distributed.

Trench 43

Length (m): 30

Width (m): 1.8

Orientation: NE-SW

Context summary:

Context	Feature type	Context type	Height/depth	Deposit description
4300	Deposit	Topsoil - Trench 43	0.20 to 0.50	Colour: dark blackish brown. Compaction: wet, friable. Composition: silty clay. Inclusions: frequent medium rounded spheroidal stone, evenly distributed.
4301	Deposit	Subsoil - Trench 43	0.30 to 0.40	Colour: mid brown. Compaction: wet, friable. Composition: sandy silt.
4302	Deposit	Natural - Trench 43		Colour: mid orangey brown. Compaction: moist, loose. Composition: well sorted sandy cobble. Inclusions: medium sub-rounded spheroidal clay and sand patches, evenly distributed.

Trench 44

Length (m): 30

Width (m): 1.8

Orientation: NW-SE

Context summary:

Context	Feature type	Context type	Height/depth	Deposit description
4400	Deposit	Topsoil - Trench 44	0.25 (avg.)	Colour: dark blackish brown. Compaction: wet, friable. Composition: silty clay. Inclusions: frequent medium rounded spheroidal stone, evenly distributed.
4401	Deposit	Subsoil - Trench 44	0.10 (avg.)	Colour: mid brown. Compaction: wet, friable. Composition: sandy silt.
4402	Deposit	Natural - Trench 44		Colour: mid orangey brown. Compaction: moist, loose. Composition: well sorted sandy cobble. Inclusions: medium sub-rounded spheroidal clay and sand patches, evenly distributed.

Trench 45

Length (m): 30

Width (m): 1.8

Orientation: N-S

Context summary:

Context	Feature type	Context type	Height/depth	Deposit description
4500	Deposit	Topsoil - Trench 45	0.29 (avg.)	Colour: dark blackish brown. Compaction: wet, friable. Composition: silty clay. Inclusions: frequent medium rounded spheroidal stone, evenly distributed.
4501	Deposit	Subsoil - Trench 45	0.30 (avg.)	Colour: bright brownish orange. Compaction: moist, friable. Composition: sandy silt.
4502	Deposit	Natural - Trench 45		Colour: mid orangey brown. Compaction: moist, loose. Composition: well sorted sandy cobble. Inclusions: medium sub-rounded spheroidal clay and sand patches, evenly distributed.

Trench 46

Length (m): 30

Width (m): 1.8

Orientation: NW-SE

Context summary:

Context	Feature type	Context type	Height/depth	Deposit description
4600	Deposit	Topsoil - Trench 46	0.25 (avg.)	Colour: dark blackish brown. Compaction: wet, friable. Composition: silty clay. Inclusions: frequent medium rounded spheroidal stone, evenly distributed.
4601	Deposit	Subsoil - Trench 46	0.20 (avg.)	Colour: mid brown. Compaction: wet, friable. Composition: sandy silt.
4602	Deposit	Natural - Trench 46		Colour: mid orangey brown. Compaction: moist, loose. Composition: well sorted sandy cobble. Inclusions: medium sub-rounded spheroidal clay and sand patches, evenly distributed.

Trench 47

Length (m): 30

Width (m): 1.8

Orientation: NW-SE

Context summary:

Context	Feature type	Context type	Height/depth	Deposit description
4700	Deposit	Topsoil - Trench 47	0.33 (avg.)	Colour: dark blackish brown. Compaction: wet, friable. Composition: silty clay. Inclusions: frequent medium rounded spheroidal stone, evenly distributed.
4701	Deposit	Subsoil - Trench 47	0.25 (avg.)	Colour: mid brown. Compaction: moist, friable. Composition: silty clay.
4702	Deposit	Natural - Trench 47		Colour: yellow. Compaction: moist, loose. Composition: medium sand.

Trench 48

Length (m): 30

Width (m): 1.8

Orientation: NW-SE

Context summary:

Context	Feature type	Context type	Height/depth	Deposit description
4800	Deposit	Topsoil - Trench 48	0.37 (avg.)	Colour: dark brown. Compaction: moist, friable. Composition: silty clay.
4801	Deposit	Subsoil - Trench 48	0.32 (avg.)	Colour: mid brown. Compaction: moist, friable. Composition: silty clay.
4802	Deposit	Natural - Trench 48	0	Colour: yellow. Compaction: moist, loose. Composition: medium sand.

Trench 49

Length (m): 30 Width (m): 1.8 Orientation: NW-SE

Context summary:

Context	Feature type	Context type	Height/depth	Deposit description
4900	Deposit	Topsoil - Trench 49	0.33 (avg.)	Colour: dark brown. Compaction: moist, friable. Composition: silty clay.
4901	Deposit	Subsoil - Trench 49	0.33 (avg.)	Colour: mid brown. Compaction: moist, friable. Composition: silty clay.
4902	Deposit	Natural - Trench 49	0	Colour: yellowish brown. Compaction: moist, loose. Composition: medium sand.

Trench 50

Length (m): 30 Width (m): 1.8 Orientation: N-S

Context summary:

Context	Feature type	Context type	Height/depth	Deposit description
5000	Deposit	Topsoil - Trench 50	0.30 (avg.)	Colour: dark blackish brown. Compaction: wet, friable. Composition: silty clay. Inclusions: frequent medium rounded spheroidal stone, evenly distributed.
5001	Deposit	Subsoil - Trench 50	0.20 (avg.)	Colour: mid brown. Compaction: wet, friable. Composition: sandy silt.
5002	Deposit	Natural - Trench 50		Colour: mid orangey brown. Compaction: moist, loose. Composition: well sorted sandy cobble. Inclusions: medium sub-rounded spheroidal clay and sand patches, evenly distributed.

Trench 51

Length (m): 30 Width (m): 1.8 Orientation: NW-SE

Context summary:

Context	Feature type	Context type	Height/depth	Deposit description
5100	Deposit	Topsoil - Trench 51	0.30 (avg.)	Colour: dark blackish brown. Compaction: wet, friable. Composition: silty clay. Inclusions: frequent medium rounded spheroidal stone, evenly distributed.
5101	Deposit	Subsoil - Trench 51	0.10 (avg.)	Colour: mid brown. Compaction: wet, friable. Composition: sandy silt.
5102	Deposit	Natural - Trench 51		Colour: mid orangey brown. Compaction: moist, loose. Composition: well sorted sandy cobble. Inclusions: medium sub-rounded spheroidal clay and sand patches, evenly distributed.

Trench 52

Length (m): 30 Width (m): 1.8 Orientation: N-S

Context summary:

Context	Feature type	Context type	Height/depth	Deposit description
5200	Deposit	Topsoil - Trench 52	0.46 (avg.)	Colour: dark brown. Compaction: moist, friable. Composition: silty clay.
5201	Deposit	Subsoil - Trench 52	0.16 (avg.)	Colour: light brown. Compaction: moist, friable. Composition: silty clay.
5202	Deposit	Natural - Trench 52	0	Colour: yellowish brown. Compaction: moist, friable. Composition: silty clay.

Trench 53

Length (m): 30 Width (m): 1.8 Orientation: NE-SW

Context summary:

Context	Feature type	Context type	Height/depth	Deposit description
5300	Deposit	Topsoil - Trench 53	0.44 (avg.)	Colour: dark brown. Compaction: moist, friable. Composition: silty clay.
5301	Deposit	Subsoil - Trench 53	0.26 (avg.)	Colour: light brown. Compaction: moist, friable. Composition: silty clay.
5302	Deposit	Natural - Trench 53	0	Colour: yellowish brown. Compaction: moist, friable. Composition: silty clay.

Trench 54

Length (m): 30 Width (m): 1.8 Orientation: N-S

Context summary:

Context	Feature type	Context type	Height/depth	Deposit description
5400	Deposit	Topsoil - Trench 54	0.36 (avg.)	Colour: dark brown. Compaction: moist, friable. Composition: silty clay.
5401	Deposit	Subsoil - Trench 54	0.05 (avg.)	Colour: light brown. Compaction: moist, friable. Composition: silty clay.
5402	Deposit	Natural - Trench 54	0	Colour: yellowish brown. Compaction: moist, friable. Composition: silty clay.

Trench 55

Length (m): 30

Width (m): 1.8

Orientation: E-W

Context summary:

Context	Feature type	Context type	Height/depth	Deposit description
5500	Deposit	Topsoil - Trench 55	0.30 (avg.)	Colour: dark brown. Compaction: moist, friable. Composition: silty clay.
5501	Deposit	Subsoil - Trench 55	0.15 (avg.)	Colour: mid brown. Compaction: wet, friable. Composition: sandy silt.
5502	Deposit	Natural - Trench 55		Colour: mid orangey brown. Compaction: moist, loose. Composition: well sorted sandy cobble. Inclusions: medium sub-rounded spheroidal clay and sand patches, evenly distributed.

Trench 56

Length (m): 30

Width (m): 1.8

Orientation: NW-SE

Context summary:

Context	Feature type	Context type	Height/depth	Deposit description
5600	Deposit	Topsoil - Trench 56	0.30 (avg.)	Colour: dark blackish brown. Compaction: wet, friable. Composition: silty clay. Inclusions: frequent medium rounded spheroidal stone, evenly distributed.
5601	Deposit	Subsoil - Trench 56	0.15 (avg.)	Colour: mid brown. Compaction: wet, friable. Composition: sandy silt.
5602	Deposit	Natural - Trench 56		Colour: mid orangey brown. Compaction: moist, loose. Composition: well sorted sandy cobble. Inclusions: medium sub-rounded spheroidal clay and sand patches, evenly distributed.

Trench 57

Length (m): 30

Width (m): 1.8

Orientation: N-S

Context summary:

Context	Feature type	Context type	Height/depth	Deposit description
5700	Deposit	Topsoil - Trench 57	0.32 (avg.)	Colour: dark brownish grey. Compaction: wet, friable. Composition: silty clay. Inclusions: frequent medium rounded spheroidal stone, evenly distributed.
5701	Deposit	Subsoil - Trench 57	0.30 (avg.)	Colour: mid reddish brown. Compaction: wet, friable. Composition: sandy silt.
5702	Deposit	Natural - Trench 57		Colour: mid orangey yellow. Compaction: moist, loose. Composition: sand.

Trench 58

Length (m): 30

Width (m): 1.8

Orientation: E-W

Context summary:

Context	Feature type	Context type	Height/depth	Deposit description
5800	Deposit	Topsoil - Trench 58	0.29 (avg.)	Colour: dark brownish grey. Compaction: wet, friable. Composition: silty clay. Inclusions: frequent medium rounded spheroidal stone, evenly distributed.
5801	Deposit	Subsoil - Trench 58	0.00 to 0.25	Colour: mid reddish brown. Compaction: wet, malleable. Composition: sandy silt.
5802	Deposit	Colluvium - Trench 58	0.00 to 0.58	Colour: mid reddish brown. Compaction: wet, friable. Composition: silty clay. Inclusions: frequent small to large sub-rounded to well-rounded spheroidal stones.
5803	Deposit	Natural - Trench 58		Colour: mid reddish orange. Compaction: moist, loose. Composition: fine sand.

Trench 59

Length (m): 30

Width (m): 1.8

Orientation: N-S

Context summary:

Context	Feature type	Context type	Height/depth	Deposit description
5900	Deposit	Topsoil - Trench 59	0.23 (avg.)	Colour: dark brownish grey. Compaction: wet, friable. Composition: silty clay. Inclusions: frequent medium rounded spheroidal stone, evenly distributed.
5901	Deposit	Subsoil - Trench 59	0.42 (avg.)	Colour: mid reddish brown. Compaction: wet, friable. Composition: sandy silt.
5902	Deposit	Natural - Trench 59		Colour: mid yellowish orange. Compaction: moist, loose. Composition: sand.

Trench 60

Length (m): 30

Width (m): 1.8

Orientation: E-W

Context summary:

Context	Feature type	Context type	Height/depth	Deposit description
6000	Deposit	Topsoil - Trench 60	0.23 (avg.)	Colour: dark brownish grey. Compaction: wet, friable. Composition: silty clay. Inclusions: frequent medium rounded spheroidal stone, evenly distributed.
6001	Deposit	Subsoil - Trench 60	0.42 (avg.)	Colour: mottled red and grey. Compaction: wet, friable. Composition: sandy clay.
6002	Deposit	Natural - Trench 60		Colour: mid orangey red. Compaction: waterlogged, loose. Composition: sandy silt.

Trench 61

Length (m): 30

Width (m): 1.8

Orientation: N-S

Context summary:

Context	Feature type	Context type	Height/depth	Deposit description
6100	Deposit	Topsoil - Trench 61	0.23 (avg.)	Colour: dark brownish grey. Compaction: moist, friable. Composition: silty clay. Inclusions: frequent medium rounded spheroidal stone, evenly distributed.
6101	Deposit	Subsoil - Trench 61	0.20 (avg.)	Colour: mid reddish brown. Compaction: moist, friable. Composition: sandy silt.
6102	Deposit	Natural - Trench 61		Colour: mottled red and grey. Compaction: moist, malleable. Composition: sandy clay.

Trench 62

Length (m): 30

Width (m): 1.8

Orientation: E-W

Context summary:

Context	Feature type	Context type	Height/depth	Deposit description
6200	Deposit	Topsoil - Trench 62	0.28 (avg.)	Colour: dark brownish grey. Compaction: wet, friable. Composition: silty clay. Inclusions: frequent medium rounded spheroidal stone, evenly distributed.
6201	Deposit	Subsoil - Trench 62	0.25 (avg.)	Colour: mid reddish brown. Compaction: wet, friable. Composition: sandy silt.
6202	Deposit	Natural - Trench 62		Colour: mid reddish orange. Compaction: moist, loose. Composition: fine sand.

Trench 63

Length (m): 30

Width (m): 1.8

Orientation: N-S

Context summary:

Context	Feature type	Context type	Height/depth	Deposit description
6300	Deposit	Topsoil - Trench 63	0.24 (avg.)	Colour: dark brownish grey. Compaction: wet, friable. Composition: silty clay. Inclusions: frequent medium rounded spheroidal stone, evenly distributed.
6301	Deposit	Subsoil - Trench 63	0.20 (avg.)	Colour: mid reddish brown. Compaction: wet, friable. Composition: sandy silt.
6302	Deposit	Colluvium - Trench 63	0.60 (avg.)	Colour: mid reddish brown. Compaction: moist, friable. Composition: sandy clay. Inclusions: moderate small to large sub-rounded to well-rounded spheroidal stones.
6303	Deposit	Natural - Trench 63		Colour: mid reddish orange. Compaction: wet, loose. Composition: fine sand.

Trench 64

Length (m): 30

Width (m): 1.8

Orientation: E-W

Context summary:

Context	Feature type	Context type	Height/depth	Deposit description
6400	Deposit	Topsoil - Trench 64	0.37 (avg.)	Colour: dark brownish grey. Compaction: wet, friable. Composition: silty clay. Inclusions: frequent medium rounded spheroidal stone, evenly distributed.
6401	Deposit	Subsoil - Trench 64	0.38 (avg.)	Colour: mid reddish brown. Compaction: wet, friable. Composition: sandy silt.
6402	Deposit	Natural - Trench 64		Colour: mid yellowish orange. Compaction: moist, loose. Composition: sand.

Trench 65

Length (m): 30

Width (m): 1.8

Orientation: N-S

Context summary:

Context	Feature type	Context type	Height/depth	Deposit description
6500	Deposit	Topsoil - Trench 65	0.25 (avg.)	Colour: dark brownish grey. Compaction: wet, friable. Composition: silty clay. Inclusions: frequent medium rounded spheroidal stone, evenly distributed.
6501	Deposit	Subsoil - Trench 65	0.32 (avg.)	Colour: mid reddish brown. Compaction: wet, friable. Composition: sandy silt.
6502	Deposit	Natural - Trench 65		Colour: mid reddish orange. Compaction: moist, loose. Composition: fine sand.

Trench 66

Length (m): 30

Width (m): 1.8

Orientation: E-W

Context summary:

Context	Feature type	Context type	Height/depth	Deposit description
6600	Deposit	Topsoil - Trench 66	0.32 (avg.)	Colour: dark brownish grey. Compaction: wet, friable. Composition: silty clay. Inclusions: frequent medium rounded spheroidal stone, evenly distributed.
6601	Deposit	Subsoil - Trench 66	0.38 (avg.)	Colour: mid reddish brown. Compaction: wet, friable. Composition: sandy silt.
6602	Deposit	Colluvium - Trench 66	0.00 to 0.55	Colour: mid reddish brown. Compaction: moist, friable. Composition: sandy clay. Inclusions: moderate small to large sub-rounded to well-rounded spheroidal stones.
6603	Deposit	Natural - Trench 66		Colour: mid reddish orange. Compaction: moist, loose. Composition: fine sand.

Trench 67

Length (m): 30

Width (m): 1.8

Orientation: N-S

Context summary:

Context	Feature type	Context type	Height/depth	Deposit description
6700	Deposit	Topsoil - Trench 67	0.38 (avg.)	Colour: dark brownish grey. Compaction: wet, friable. Composition: silty clay. Inclusions: frequent medium rounded spheroidal stone, evenly distributed.
6701	Deposit	Subsoil - Trench 67	0.31 (avg.)	Colour: mid reddish brown. Compaction: wet, friable. Composition: sandy silt.
6702	Deposit	Natural - Trench 67		Colour: mid reddish orange. Compaction: moist, loose. Composition: fine sand.

Appendix 2: Summary of project archive (RTA 1170)

TYPE	DETAILS*
Artefacts and Environmental	Ceramics, Environmental, Bone
Paper	Drawing, Plan, Section, Survey
Digital	Database, GIS, Images raster/digital photography, Spreadsheets, Survey, Text

**OASIS terminology*

The project archive is currently held at the offices of Worcestershire Archaeology. Subject to the agreement of the landowner it is anticipated that it will be deposited at Warwickshire Museum.

Appendix 3: Summary of data for HER

trench	context	material class	object specific type	material subtype	count	weight (g)	comments	period
2	205	ceramic	pot		1	19	Small base in fine oxidised fabric	Roman
5	504	ceramic	pot		70	449	Grooved ware	Late Neolithic
6	604	ceramic	pot		1	13	Oxidised, grog-tempered fabric with slightly blackened surface and cordon	?late Iron Age/early Roman
10	1004	ceramic	pot		5	117	Rim, very friable body. Flat topped ovoid/barrel shaped jar with row of fingertipping 2.5cm below rim	late Bronze Age
10	1004	ceramic	pot		4	18	Highly abraded fragments. From sample 2	prehistoric
10	1007	ceramic	pot		4	14	Highly abraded ?base and body	?later prehistoric
10	1008	ceramic	pot		3	4	Oxidised exterior with faint ?lattice	?Roman
25	2502	ceramic	pot		1	11	Impressed ware. From sample 4	middle Neolithic
25	2504	ceramic	pot		3	19	Impressed ware	middle Neolithic
39	3904	ceramic	pot		5	49	Small jar with neck and upright rim. Sandy fabric, black	middle-late Iron Age
39	3904	ceramic	pot		2	3	Fragments of sandy oxidised fabric with small ?rock inclusions. From sample 1.	undated
39	3904	metal	object		1	19	Highly corroded ring - not perfectly round. Unsure of function - ?fitting	undated
					100	735		

Table 1: Quantification of site assemblage by context

Number	Reason	Context	Context title
1	Environmental	3904	Fill - Tree throw [3903]
2	Carbon dating	1004	Fill - Pit [1003]
3	Bulk	504	Fill - Ditch [503]
4	Bulk	2504	Fill - Pit [2505]
5	Bulk	3203	Fill - Pit [3204]

Table 2 : List of samples processed for further analysis (all 10L tubs)